



Qualified Pavement Markings Inspection Technician

Brandi R. Mitchell
Division of Materials
Brandi.Mitchell@ky.gov
502.782.8382

Sarah E. Ramsay
Division of Materials
Sarah.Ramsay@ky.gov
502.782.8386

COURSE SCHEDULE

DAY 1

8:30 – 9:30am Introduction and Welcome
KM64-001 Qualification Program for Technicians
Specifications
District Wide Striping Contract

9:30 – 9:45am **BREAK**

9:45 – 10:45am Materials Handling
Kentucky Methods

10:45 – 11:30am LTL-X Overview

11:30 – 1:00pm **LUNCH**

1:00 – 4:00pm Workshops

DAY 2

8:30 – 9:00am Review

9:00 – UNTIL Written and Practical Exam

*Between the written and practical exam, participants will have an opportunity to take a break and practice for the second part of the exam.

WEBSITES

Kentucky Methods

<http://transportation.ky.gov/Materials/Pages/Kentucky-Methods.aspx>

2012 Specifications

<http://transportation.ky.gov/Construction/Pages/Kentucky-Standard-Specifications.aspx>

Sampling Manual

<http://transportation.ky.gov/Materials/Pages/Sampling-Manual.aspx>

Daily Striping Report/ KM202 Spreadsheet

<http://transportation.ky.gov/materials/pages/Chemistry.aspx>

**QUALIFIED
PAVEMENT MARKING
TECHNICIAN
TRAINING**

INTRODUCTION & WELCOME

1. Visitor Check-In & Out
2. Restrooms & Concessions

REASON FOR THE COURSE

KM 64-001

According to the Federal Highway Administration Policy all acceptance sampling and testing must be performed by “Qualified Personnel.” In response to the federal policy, the state Qualification Program for Technicians was developed.

Kentucky Method 64-001-08 covers qualification and disqualification procedures for inspectors. This method states that to qualify you must attend training and pass both a written test and a practical test. Disqualification is the result of one of the following reasons:

1. Failure to pass re-qualification class
2. Found to be guilty of falsifying test results, records, and/or reports.
3. Improper performance of tests

As of 2016 the Qualified Pavement Markings Inspection Technician course qualification is good for five (5) years (as opposed to only three years in the past).

OVERVIEW OF THE COURSE

DAY 1

This course will begin by discussing the Specifications that cover striping. Then we will review the district wide striping contract followed by a short break. After the break we will go over the Materials testing and finish with the Kentucky Methods. Finally, we will finish the morning with an overview of the LTL-X. Following lunch, we will have workshops that include hands-on practice with the LTL-X instrument.

All participants must attend both the morning presentations AND the workshops in order to be eligible to take the exam.

DAY 2

At the start of the day we will have a brief **question and answer session** followed by an open book written exam. After the **written exam**, there is a **practical test**. For the practical exam the manuals are not allowed. Also, the practical will include written questions.

NO RETEST

TIPS

1. Follow along during the class so that you are familiar with your manual
2. Practice with the LTL-X until you are comfortable

Kentucky Method 64-001-17
Revised 02/22/17
Supersedes KM 64-001-08
Dated 04/02/08

KENTUCKY TRANSPORTATION CABINET
QUALIFICATION PROGRAM FOR TECHNICIANS

1. SCOPE:
 - 1.1. According to Title 23, Part 637, Code of Federal Regulations (23 CFR 637), FHWA's "Quality Assurance Procedures for Construction", all acceptance and verification sampling and testing must be performed by "qualified personnel".
 - 1.2. As defined in the Quality Assurance Program for Materials Testing and Acceptance, the Kentucky Department of Highways has established a Quality Assurance (QA) program to ensure that materials and workmanship incorporated into any highway construction project are in reasonable conformity with the requirements of the approved plans and specifications, including any approved changes. This QA program allows for the use of validated, contractor-performed, quality control (QC) test results as part of an acceptance decision. It also allows for the use of test results obtained by commercial laboratories in the Independent Assurance (IA) program as well as in acceptance decisions.
2. REFERENCED DOCUMENTS: Kentucky Department of Highways Quality Assurance Program for Materials Testing and Acceptance
3. QUALIFICATION PROGRAM STEERING COMMITTEE (QPSC): The Qualification Program is overseen by a Steering Committee consisting of the following representatives:
 - State Highway Engineer
 - Deputy State Highway Engineer for Project Delivery
 - Director, Division of Construction
 - Director, Division of Materials
 - Director, Division of Employee Support
 - Division of Materials Qualification Coordinator
 - Representative, Federal Highway Administration
 - Representative, Kentucky Concrete Association (KCA)
 - Representative, Kentucky Association of Highway Contractors (KAHC)
 - Representative, Kentucky Crushed Stone Association (KCSA)
 - Representative, Plantmix Asphalt Industry of Kentucky (PAIKY)

4. QUALIFICATION POLICIES:

- 4.1. Required qualifications are primarily: 1) sample and test oriented or 2) demonstration of knowledge or expertise for a specific discipline.
 - 4.1.1. Qualifications required for sampling and testing as part of a QA program. These qualifications are required, as applicable, for the QC effort, acceptance, verification, or IAS program. To qualify, an individual must successfully perform the specific tests and necessary calculations required for each qualification type in the presence of an authorized evaluator. Successful performance is defined as demonstrating the ability to properly perform the key elements for each test method. If the individual fails to demonstrate the ability to perform a test, the individual may be allowed one retest per test method at the evaluator's discretion.
 - 4.1.2. Qualifications required for demonstration of knowledge or expertise associated with items of work. These qualifications are required, as applicable, for project oversight when specific items of work are being performed.
- 4.2. The individual must pass a written examination administered by an authorized evaluator. An individual failing the written examination may request a retest. The individual may be allowed one retest at the evaluator's discretion. The retest must be requested, scheduled and administered within 30 days of the notification of failure. Failure to pass the second written examination shall be considered as failing the entire qualification.
- 4.3. Qualification of an individual is valid for not more than five years. After that time, the individual must qualify again. Under the requirements of the QA program, interim evaluations will be permitted when appropriately justified.
- 4.4. Test questions and other examination data used to administer this qualification program are subject to reuse and are considered confidential and exempt from public records inspection.

5. EXAMINATION METHODS AND POLICIES:

- 5.1. A standard set of examinations for each qualification will be used statewide. With the exception of national qualifications, the examinations will be developed by a committee composed of personnel from some or all of the following: Division of Materials, Division of Construction, and appropriate industry representatives.
- 5.2. In addition, the individual may be required to participate in proficiency sample testing administered by the qualification authority to validate the qualification. The result of the proficiency samples will be evaluated for compliance with acceptable tolerance limits. If the comparison of test results does not comply with the tolerances, an engineering review of the test procedures and equipment shall be performed immediately to determine the source of the discrepancy. Corrective actions must be identified, and incorporated as appropriate, prior to the individual performing additional testing on that test method.

6. DISQUALIFICATION PROCEDURES: A qualified individual can be disqualified for any of the following reasons:
- 6.1. Failure to pass requalification requirements and/or provide payment of fees, initial or requalification.
 - 6.2. Found to be guilty of falsifying test results, records, and/or reports or any willful departure from approved policy/procedure. Allegations of falsification or willful departure will be made to the QPSC in writing. The allegations will contain the name, address, and signature of the individual(s) making the allegation. The allegations will be investigated by the QPSC. The accused and the individual(s) making the allegation will be given the opportunity to appear before the QPSC. All involved parties will be notified in writing of the findings by the QPSC. Any warranted actions will be imposed according to the guidance contained herein. Decisions regarding allegations may be appealed in writing to the QPSC which will consider such written appeals and take such action considered appropriate.
 - 6.2.1. First offense would result in a 12-month revocation of qualification status in all qualification types. Prior to reinstatement, the individual shall again successfully complete qualification classes.
 - 6.2.2. Second offense would result in a permanent loss of qualification status in all qualification types.
 - 6.3. Found to be guilty of improperly performing tests, failing to perform tests, or being incapable of performing tests and documented by a qualified technician. The documentation ("Report of Violation" form, copy attached) must include the date(s), time(s), location(s), occurrence(s) of non-conformance, and signature of the qualified technician reporting the incident.
 - 6.3.1. First offense would result in a letter of reprimand from the QPSC.
 - 6.3.2. Second offense would result in a 30-day revocation of qualification status.
 - 6.3.3. Third offense would result in a revocation of qualification status. The individual may obtain qualification again after a six-month period and successfully completing the appropriate qualification class(es).

APPROVED

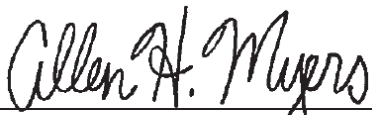

 DIRECTOR
 DIVISION OF MATERIALS

DATE

02/22/17

Kentucky Method 64-001-17
 Revised 02/22/17
 Supersedes KM 64-001-08
 Dated 04/02/08

SPECIFICATIONS



Pavement Marking Inspection

- Temporary Striping
- Permanent Pavement Striping
- Durable Pavement Striping
- Intersection Markings

sbatpiper 2002

This slide features a title 'Pavement Marking Inspection' in green. It includes four bullet points: 'Temporary Striping', 'Permanent Pavement Striping', 'Durable Pavement Striping', and 'Intersection Markings'. There are three images: a top-left photo of a parking lot with white lines, a top-right close-up of a yellow arrow, and a bottom-center photo of a road with 'ONLY' painted on it. A small signature 'sbatpiper 2002' is at the bottom.



Standard Specifications for Temporary Striping

► **Section 112.03.11:**
Temporary Striping with Paint or Tape

This slide has a title 'Standard Specifications for Temporary Striping' in green. Below it is a sub-section header '► Section 112.03.11: Temporary Striping with Paint or Tape'. To the right is a photo of a road with temporary white striping.



Section 112.03.11: Temporary Striping

- **Striping expected to be in place less than 120 days**
 - Visual Acceptance
 - Maintained Retroreflectivity Readings
 - Manufacturer's Certification
 - Tape: Ensure the product is on the List of Approved Materials
- **Striping expected to be in place greater than 120 days**
 - Initial Retroreflectivity Readings
 - Maintained Retroreflectivity readings
 - Manufacturer's Certification
 - Paint: Collect a sample to be sent to Central Office Materials
 - Tape: Ensure the product is on the List of Approved Materials

This slide is titled 'Section 112.03.11: Temporary Striping'. It contains two main bullet points. The first is 'Striping expected to be in place less than 120 days' with sub-bullets for 'Visual Acceptance', 'Maintained Retroreflectivity Readings', 'Manufacturer's Certification', and 'Tape: Ensure the product is on the List of Approved Materials'. The second is 'Striping expected to be in place greater than 120 days' with sub-bullets for 'Initial Retroreflectivity Readings', 'Maintained Retroreflectivity readings', 'Manufacturer's Certification', 'Paint: Collect a sample to be sent to Central Office Materials', and 'Tape: Ensure the product is on the List of Approved Materials'.

Section 112.03.11: Initial Evaluation of Temporary Stripe

- ▶ **Less than 120 days**
 - ▶ Initial evaluation = Visual Evaluation
- ▶ **Greater than 120 days**
 - ▶ Initial Evaluation = Retroreflectivity within 5 days of application
 - ▶ White: 300 mcd/m²/Lux
 - ▶ Yellow: 225 mcd/m²/Lux

Readings taken in accordance with KM202 or KM203



Section 112.03.11: Temporary Striping Minimum Maintained Retroreflectivity

- ▶ **Minimum retroreflectivity maintained as long as the temporary stripe is in place**
 - ▶ **Stripe in place less than 120 days**
 - ▶ Requested at any time by the Engineer
 - ▶ **Stripe in place greater than 120 days**
 - ▶ Requested any time after initial evaluation by the Engineer

White: 175 mcd/m²/Lux
Yellow: 150 mcd/m²/Lux

Readings taken in accordance with KM202 or KM203.

Section 112.03.11: Temporary Striping Visual Acceptance Guidelines

- ▶ **Suitable and uniform color**
- ▶ **Crisp edges and clean cutoffs**
- ▶ **Adhere to pavement**
- ▶ **Sufficient retroreflectivity - visible daytime and nighttime**





Section 112.03.11: Corrective Work for Temporary Stripe

- ▶ Unacceptable initial evaluation
 - ▶ Corrective work completed within 24 hours
- ▶ Damaged or missing stripe during the course of the contract
 - ▶ Replace within 3 days



Section 112.03.11: Temporary Stripe Review Questions

- ▶ If the temporary stripe is only expected to be in place for two months, what type of initial evaluation do you need to perform?
- ▶ If the temporary stripe is expected to be in place for 6 months, what type of initial evaluation should you perform?

**Section 112.03.11:
Temporary Stripe Review Questions**

- ▶ A temporary stripe has been in place for 90 days but at night the line is barely visible. What minimum values should the line be?
- ▶ If the line is below these values, how long does the contractor have to replace the temporary stripe?



Standard Specifications

- Section 713: Permanent Pavement Striping
- Section 714: Durable Pavement Striping
- Section 717: Thermoplastic Intersection Markings

Section 713

**Permanent Pavement Marking
Paints**

On



**Resurfacing, Restoration and
Rehabilitation Contracts**

**Section 713:Perment Striping
Materials**

- ▶ Waterborne Traffic Paint
 - ▶ Conform to Section 842
- ▶ Durable Waterborne Traffic Paint
 - ▶ Conform to Section 846



**Section 713:Permanent Striping
Minimum Application Rates**

4" Waterborne paint - 16.5 gallons/mile

6" Waterborne paint - 24.8 gallons/mile

6" Durable waterborne paint - 36 gallons/mile

Glass beads - 6 pounds/gallon



Section 713: Permanent Striping Proving Period

- ▶ Proving period - facility open to traffic
- ▶ Readings to be taken 30-60 days after proving period begins
- ▶ Minimum retroreflectivity requirements

White: 300 mcd/m²/lux
Yellow: 225 mcd/m²/lux



Section 713: Permanent Striping Pass/Fail Decisions

- ▶ **KM202**
 - ▶ 80% of the readings in each segment must pass
- ▶ **KM203**
 - ▶ 80% of the segments in each section must pass
- ▶ **Acceptance with Deduction**
 - ▶ Use if all other work is in conformity except retroreflectivity
 - ▶ Weather conditions prohibit corrective work
 - ▶ Sliding scale

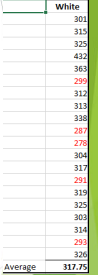

Section 713: Permanent Striping Acceptance Pay Schedule

Pay Value	White (mcd/m ² /lux)	Yellow (mcd/m ² /lux)
1.00	≥ 300	≥ 225
0.50	251-299	176-224
0.25	226-250	151-175
0.00	200-225	125-150
Remove & Replace	< 200	< 125



Section 713: Permanent Striping Marking Removal

- Use ultra-high pressure water to remove markings
- Markings removal totaling less than 1,000 linear feet may be removed by an abrasive method
- **Do not** paint markings made in error or not in conformance with asphalt binder or other material
- **Do not** damage pavement in any way while removing markings and protect all joint seals

Section 714

Durable Striping

Type I Tape
&
Extruded Thermoplastic

Section 714: Durable Striping Type I Tape

- ▶ Use for markings on bridge decks, JPC pavement and JPC intersection
- ▶ **Do not** use thermoplastic on bridge decks, JPC pavement and JPC intersections

Section 714: Durable Striping Type I Tape

- ▶ **Materials Requirements (Section 836)**
 - ▶ Manufacturer's Certification
 - ▶ Must meet the minimum retroreflectivity requirements
 - ▶ White = 500 mcd/m²/lux
 - ▶ Yellow = 500 mcd/m²/lux

Section 714: Durable Striping Proving Period for Type I Tape

- ▶ Blistering
- ▶ Excessive cracking
- ▶ Bleeding
- ▶ Staining
- ▶ Discoloration
- ▶ Oil content from pavement markings
- ▶ Chipping
- ▶ Spalling
- ▶ Loss of Retroreflectivity
- ▶ Vehicular damage
- ▶ Deterioration due:
 - ▶ Grease deposits
 - ▶ Oil
 - ▶ Diesel fuel
 - ▶ Gasoline
- ▶ Adequate bonding to the pavement



Section 714: Durable Striping Nighttime Visual Acceptance

- ▶ **Retroreflectivity readings are not necessary if**
 - ▶ Material shows no sign of failure
 - ▶ Adequately bonded to the pavement
- ▶ **Acceptance**
 - ▶ Nighttime visual evaluation
 - ▶ Manufacturer's certification

Section 714: Durable Striping Extruded Thermoplastic

- ▶ **Minimum application rate**
 - ▶ 90 mil line
- ▶ 1 foot gap every 20 feet



Section 714: Durable Striping Equipment Requirements for Thermoplastic

- ▶ DO NOT use a spray or ribbon gun applicator
- ▶ Extrusion die deposits and shapes lines
- ▶ Maintain continuous and uniform heating between 400 and 440°F
- ▶ Kettle capable of continuous agitation
- ▶ Motorized and capable of applying line at a rate of 3 mph
- ▶ Cut off device to provide clean, square ends
- ▶ Automated bead dispenser



Section 714: Durable Striping Perform Bond Checks

- ▶ Check 60 to 120 seconds after application of stripe
- ▶ Cut 6 inch strip
- ▶ Bonding has successfully occurred if asphalt clings to the removed strip and the pavement surface is shiny and black



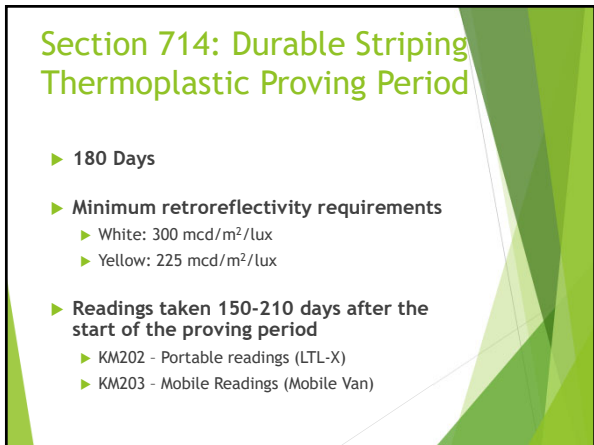

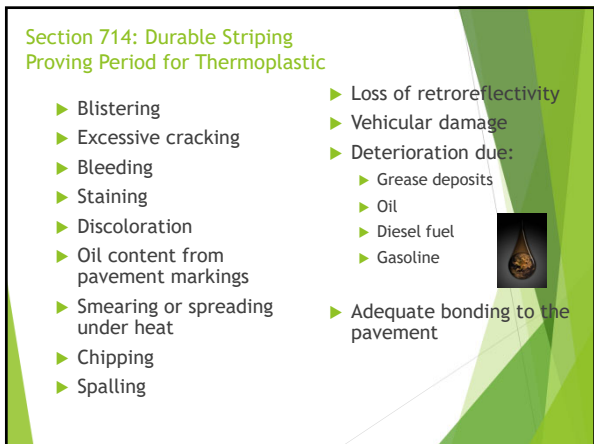

Section 714: Durable Striping Acceptance Pay Schedule

Pay Value	White (mcd/m ² /lux)	Yellow (mcd/m ² /lux)
1.00	≥ 300	≥ 225
0.50	251 - 299	176 - 224
0.25	226 - 250	151 - 175
0.00	200 - 225	125 - 150
Remove and Replace	< 200	< 125



Section 717 Intersection Markings

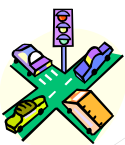

Section 717: Intersection Markings

- ▶ **Preformed Thermoplastic**
 - ▶ List of approved materials
 - ▶ 125 mil minimum thickness
- ▶ **Extruded Thermoplastic**
 - ▶ 90 mil line
- ▶ **Type I Tape**

Section 717: Intersection Markings Equipment Requirements

- ▶ DO NOT use a spray or ribbon gun applicator
- ▶ Extrusion die deposits and shapes lines
- ▶ Maintain continuous and uniform heating between 400 and 440°F
- ▶ Kettle capable of continuous agitation
- ▶ Motorized and capable of applying line at a rate of 3 mph
- ▶ Cut off device to provide clean, square ends
- ▶ Automated bead dispenser



Section 717: Intersection Markings Restrictions

- ▶ DO NOT APPLY IF
 - ▶ Air and Pavement Temperature < 50°F



Section 717: Intersection Markings Proving Period

- ▶ Proving period - 180 days
- ▶ Minimum retroreflectivity requirements
 - ▶ White = 300 mcd/m²/lux
 - ▶ Yellow = 225 mcd/m²/lux
- ▶ Take readings 15-45 days after the start of the proving period
 - ▶ Readings taken according to KM201

Section 717: Acceptance Pay Schedule for Intersection Markings

Pay Value	White (mcd/m ² /lux)	Yellow (mcd/m ² /lux)
1.00	≥ 300	≥ 225
0.50	251 - 299	176 - 224
0.25	226 - 250	151 - 175
0.00	200 - 225	125 - 150
Remove and Replace	< 200	< 125

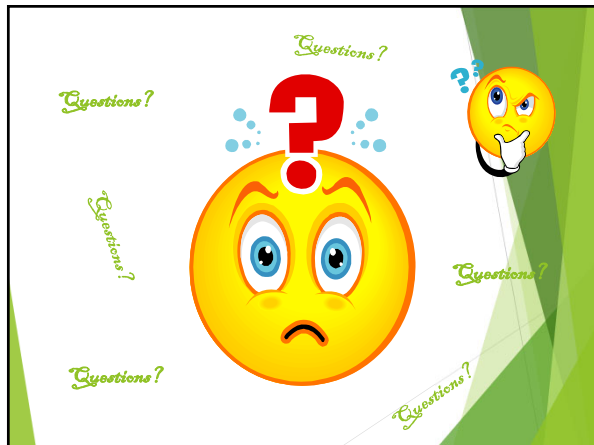

EXCERPT FROM SECTION 112- MAINTENANCE AND CONTROL OF TRAFFIC DURING CONSTRUCTION

112.03.10 Removal of Permanent Pavement Markings. Remove all permanent markings and raised pavement markers that do not conform to the traffic operation in use. Remove striping according to Section 713.03.04. Remove raised pavement markers according to Subsection 403.03.02.

When the marker's casting will conform to the final marking scheme but does not conform to the current traffic operation, the Department may allow lens removal in place of removing the entire marker. Additionally, when weather would prohibit patching for marker removal within 24 hours, the Department may allow lens removal until such time weather permits patching.

112.03.11 Temporary Pavement Markings.

A) Placement and Removal of Temporary Raised Pavement Markers. Place and remove temporary raised pavement markers when the Contract specifies. Install temporary pavement markers according to the manufacturer's recommendations. Replace missing or damaged temporary markers within 3 calendar days. After completion of the work, remove the markers from the job site, including the primer and adhesive. Take ownership of the temporary markers at the end of the project.

B) Placement and Removal of Temporary Striping. Place temporary striping on new construction, resurfacing, pavement restoration, pavement rehabilitation and other projects that have existing pavement markings as the Contract specifies. On interstates and parkways, and other roadways approved by the State Highway Engineer, install pavement striping that is 6 inches in width. On other routes, install pavement striping that is 4 inches in width. Ensure that all lines have clean edges with a width tolerance of plus 1/2 inch.

Except on new construction or where markings do not exist, prepare and keep a written record of the existing pavement markings locations, and furnish a copy to the Engineer before removing or obliterating the markings.

Apply temporary striping when any course of a new pavement is to be driven over by the public, including patching, milling, leveling, and wedging courses, except when existing centerline markings are plainly visible and not obscured. Install the pavement marking material for centerlines and lane lines every day before sunset that day. The Department will defer installation of edgeline markings until all shoulder paving is complete, except on Interstate and Parkway roads or when the Contract specifies otherwise. When rain or other unavoidable occurrences prevent marking before sunset, mark the pavement as soon as conditions permit. Locate no passing zones as the Engineer directs.

- 1) **Removable Striping.** Use removable striping tape when different phases of construction will require the relocation of striping to different positions on the same pavement. Relocate lane lines, edgelines, and other pavement markings as the Standard Drawings and the Contract specify. Do not use removable material as a permanent marking unless the Engineer directs.
- 2) **Non-removable striping material.** Use either tape or paint where the striping is to be covered by subsequent paving courses and for temporary paved facilities which will be removed before completing the project. Apply paint according to Section 713.

Maintain the following minimum retroreflectivity requirements at all times:

White: 175 mcd/lux/square meter

Yellow: 150 mcd/lux/square meter

Additionally, when temporary striping that is to remain in use for more than 120 days, provide striping with the following minimum initial retroreflectivity readings:

White: 300 mcd/lux/square meter

Yellow: 225 mcd/lux/square meter

The Engineer may visually accept the markings intended for less than 120 days use but may obtain retroreflectivity readings at any time conformance to the minimum retroreflectivity readings are in doubt. When striping that is to remain in use for more than 120 days, the Department will obtain retroreflectivity readings within five days of application of temporary striping using an approved 30 meter geometry handheld or mobile retroreflectometer. The Department will determine acceptance of the temporary striping in accordance with KM-202 or KM-203 as applicable. When the Department determines the striping is not acceptable, complete corrective work within 24 hours.

Maintain all markings throughout the duration of the project. Replace missing or damaged stripes or tape within 3 days. Remove all markings placed in error or markings that do not conform to the traffic scheme in use.

SECTION 713 — PERMANENT PAVEMENT STRIPING

713.01 DESCRIPTION. Furnish and apply waterborne striping paint to provide lane lines, edgelines, and gore markings as specified in the Contract.

713.02 MATERIALS AND EQUIPMENT.

713.02.01 Paint. Conform to Section 842 and Section 846.

713.02.02 Drop On Glass Beads. Use beads that will ensure the pavement marking material will meet retroreflectivity requirements. The Department will evaluate the beads as part of the marking system through retroreflectivity readings.

713.02.03 Application Equipment. Use a self-propelled striper capable of heating the paint to provide uniform flow. Ensure that the striper has a guide boom or optical pointer to attain smooth and straight lines. Ensure that the equipment maintains proper application pressures for paint and beads at all times. Provide equipment capable of applying a single line or parallel lines of the specified width and in any combination of a skip line and a solid line in one pass.

Provide equipment with a paint cutoff device to provide clean, square marking ends of the paint lines.

Equip the paint pots or tanks with an agitator that will keep the paint thoroughly mixed.

Provide equipment with bead dispensers, minimum of one for each paint spray gun, placed such that the beads are applied to the paint almost instantly as the paint is being placed on the roadway surface. Design and align the bead dispensers so that beads are applied under air pressure uniformly to the entire surface of the paint lines. Equip the bead dispensers with cutoff controls synchronized with the cutoff controls for the paint spray guns.

713.03 CONSTRUCTION. Provide yellow centerline markings, which are defined as those separating traffic moving in opposite directions. Provide white lane line markings, which are defined as those separating traffic moving in the same direction. Ensure that these markings are skip lines and solid lines as required by Part 3 of the MUTCD. Ensure that edge lines are solid lines, and determine the color from Part 3 of the MUTCD.

On interstates and parkways, and other routes approved by the State Highway Engineer, install pavement striping that is 6 inches in width. On other routes, install pavement striping that is 4 inches in width. When centerline markings consist of a double yellow line (either a one-direction or two-direction no passing zone marking), the spacing between the two lines shall be the same as the width of one line marking. Ensure that all lines have clean edges with a width tolerance of plus 1/2 inch. The Engineer may waive the tolerances when deviations are caused by undulation in the pavement surface.

Construct skip lines with a stripe-to-gap ratio of a 10-foot paint stripe to a 30-foot gap. Ensure that the length of the stripe is between 10 and 10 1/2 feet. Ensure that the stripe-gap cycle is between 40 and 40 1/2 feet. Offset longitudinal lines at least 2 inches from longitudinal pavement construction joints. Offset longitudinal lane lines on multi-lane highways 2 inches towards the median.

On resurfacing, pavement restoration, and pavement rehabilitation projects, reinstall the recorded existing pavement markings as modified by the Engineer. On new construction, place the markings as the Contract specifies or as the Engineer directs.

713.03.01 Records. On resurfacing, pavement restoration, and pavement rehabilitation projects, prepare and keep a written record of the locations of existing pavement markings, and furnish a copy to the Engineer before removing or obliterating the markings.

713.03.02 Pavement Surface Preparation. Clean grease, oil, mud, dust, dirt, grass, loose gravel, or other deleterious material from the surface where pavement markings are to be applied. Use only Engineer approved cleaning methods.

713.03.03 Paint Application. Apply permanent striping to new pavements when the final surface course has been placed and subsequent paving operations will not adversely impact the permanent striping. When subsequent paving operations will adversely impact the permanent striping, apply temporary striping according to Section 112.03.11 and apply the permanent striping as soon as conditions permit. Apply striping before sunset on new pavement that is to be driven over by the public.

Comply with the following application rates.

Material	Paint Application Rate	Glass Bead Application Rate
4 inch waterborne paint	Min. of 16.5 gallons/mile	Min. of 6 pounds/gallon
6 in waterborne paint	Min. of 24.8 gallons/mile	Min. of 6 pounds/gallon
6 inch durable waterborne paint	Min. of 36 gallons/mile	Min. of 6 pounds/gallon

713.03.04 Marking Removal. Remove all markings made in error or not conforming to the traffic operation in use. Do not paint with asphalt binder or other material to obliterate the markings. Remove pavement striping, temporary or permanent, from asphalt or concrete pavement using ultra-high pressure water. Marking removal totaling 1,000 linear feet or less may be removed by an abrasive method to the satisfaction of the Engineer. Vacuum all marking material and removal debris concurrently with the marking removal operation.

Do not damage the pavement in any way and protect all joint seals. If damage is observed, stop the removal process until the operation can provide an acceptable marking removal. Repair any damage to the pavement as a result of the marking removal. Removal of marking will not be measured for payment.

Waterblast to remove temporary or permanent striping completely as the Engineer directs.

713.03.05 Proving Period. A proving period will follow the application of the permanent pavement striping. During this period, the Engineer will make such observations as are necessary to determine if the markings are acceptable. The proving period begins when the facility is opened to traffic.

A) Requirements. The minimum retroreflectivity requirements at the end of the proving period, as measured with a Department approved 30 meter geometry handheld or mobile retroreflectometer, are as follows:

White: 300 mcd/lux/square meter
 Yellow: 225 mcd/lux/square meter

The Department will take these measurements between 30 and 60 days after the start of the proving period, with acceptance based on KM 202 or KM 203 as applicable. If the Department determines that the markings are acceptable, the installation of the markings will be considered complete.

B) Failure. For any one-mile section and each gore area during the proving period, the Department will consider the section defective when the retroreflectivity falls below the minimum required. The Department will consider each edge line, centerline, lane line and gore area marking separately.

C) Corrective Work. If a line is found to be defective, repair or remove and replace the line. Perform pavement marking replacement according to the

requirements specified in this subsection for the initial application. The corrective work will be subject to a proving period as listed above.

713.03.06 Acceptance of Non-Specification Markings. If weather conditions allow, perform corrective work to bring striping retroreflectivity into conformance. If corrective work has been performed and the work meets all requirements except for minimum retroreflectivity, the Department may accept the work according to Subsection 105.04. When the Engineer determines that the markings may be left in place, the Department will accept them at a reduction in the Contract unit bid price according to the Acceptance Pay Schedule. Additionally, the Engineer may remove the striping crew for the remainder of the project according to Subsection 108.06 Part A).

The Engineer may also apply this section when corrective work cannot be performed due to weather.

ACCEPTANCE PAY SCHEDULE FOR PERMANENT STRIPING		
Pay Value	White mcd/lux/square meter	Yellow mcd/lux/square meter
1.00	≥300	≥225
0.50	251-299	176-224
0.25	226-250	151-175
0.00	200-225	125-150
Remove and Replace	< 200	< 125

713.04 MEASUREMENT.

713.04.01 Pavement Striping. The Department will measure the quantity in linear feet. When a bid item is not included for gore markings, the Department will measure the quantity by converting the actual length and width of line installed to an equivalent length of the normal width line on that section of roadway. The Department will measure temporary striping according to 112.04.07 when subsequent paving operations will adversely impact the permanent striping.

713.05 PAYMENT. The Department will make payment for the completed and accepted quantities under the following:

<u>Code</u>	<u>Pay Item</u>	<u>Pay Unit</u>
06514-06517	Pavement Striping - Permanent Paint, Width	Linear Foot
24189ER	Durable Waterborne Marking – 6 IN W	Linear Foot
24190ER	Durable Waterborne Marking – 6 IN Y	Linear Foot
24191ER	Durable Waterborne Marking – 12 IN W	Linear Foot

The Department will consider payment as full compensation for all work required under this section.

SECTION 714 — DURABLE PAVEMENT STRIPING

714.01 DESCRIPTION. Furnish and install durable marking materials, thermoplastic or Type I tape, to provide lane lines, edgelines, and gore markings as specified in the Contract.

714.02 MATERIALS AND EQUIPMENT.

714.02.01 Thermoplastic. Conform to Section 837.

714.02.02 Type I Tape. Conform to Section 836.

714.02.03 Binder. Furnish a binder that the manufacturer of the pavement marking material recommends and the Engineer approves. Provide a binder that forms a continuous film that dries rapidly and adheres to the pavement. Provide a material that does not discolor or cause any noticeable change in the appearance of the pavement outside of the finished pavement marking. Submit the material and method of application to the Engineer and obtain written approval from the Engineer and the manufacturer of the pavement marking material before applying.

714.02.04 Drop On Glass Beads. Use beads that will ensure the pavement marking material will meet retroreflectivity requirements. The Department will evaluate the beads as part of the marking system through retroreflectivity readings.

714.02.05 Thermoplastic Application Equipment. Provide equipment with an extrusion die that simultaneously deposits and shapes lines at a minimum thickness of 90 mils on the pavement surface. Do not use spray and ribbon gun applicators.

Ensure the application equipment conforms to the following:

- 1) Capable of providing continuous and uniform heat to maintain the material between 400 and 440 °F throughout the mixing, conveying, and dispensing.
- 2) The kettle is capable of continuous agitation during mixing and heated storage and is equipped with an automatic thermostat control device and material thermometer.
- 3) Motorized and capable of applying a uniform line at a rate of 3 mph.
- 4) Equipped with a cutoff device that provides clean, square stripe ends.
- 5) Equipped with an automatic bead dispenser.

714.03 CONSTRUCTION. Provide yellow centerline markings, which are defined as those separating traffic moving in opposite directions. Provide white lane line markings, which are defined as those separating traffic moving in the same direction. Ensure that these markings are skip lines and solid lines as required by Part 3 of the MUTCD. Ensure that edge lines are solid lines, and determine the color from Part 3 of the MUTCD.

Install pavement striping at the width specified in the Contract. Ensure that all lines have clean edges with a width tolerance of plus 1/2 inch. The Engineer may waive the tolerances when deviations are caused by undulation in the pavement surface.

Construct skip lines with a stripe-to-gap ratio of a 10-foot stripe to a 30-foot gap. Ensure that the length of the stripe is between 10 and 10.5 feet. Ensure that the stripe-gap cycle is between 40 and 40.5 feet.

Use Type I Tape for markings on bridge decks, JPC pavement and JPC intersections. Do not use thermoplastic materials on bridge decks, JPC pavement and JPC intersections.

714.03.01 Layout. Install all pavement markings according to Part 3 of the MUTCD and the following requirements.

Make the width of lane lines and edgelines as specified in the Plans or as the Engineer directs. Make lines for gore area markings twice the normal width line for that section of roadway.

Unless striping plans are included in the proposal or otherwise directed by the Engineer, install gore area markings as shown in Figures 3B-8 and 3B-9 of the MUTCD. Do not use the optional markings shown (transverse lines in the neutral area and dotted extension of the right edgeline).

Due to the possibility that water may be retained on the roadway by the thermoplastic edgelines, place a one foot gap every 20 feet in all thermoplastic edgelines. Do not install gaps for taped edgelines.

Offset longitudinal lines at least 2 inches from longitudinal pavement construction joints. Offset longitudinal lane lines on multi-lane highways 2 inches towards the median.

On resurfacing, pavement restoration, and pavement rehabilitation projects, prepare and keep a written record of the locations of existing pavement markings, and furnish a copy to the Engineer before removing or obliterating the markings. The Engineer will notify you of any changes to the existing markings.

Before applying the pavement marking material, pre-mark the pavement surface and obtain the Engineer's approval of the proposed location, alignment, and control guides.

714.03.02 Surface Preparation.

- 1) Remove existing pavement markings and clean grease, oil, mud, dust, dirt, grass, loose gravel, or other deleterious material from the surface where pavement markings are to be applied, as directed by, and by methods acceptable to, the Engineer.
- 2) Remove the existing pavement markings until a minimum of 90 percent of the pavement surface is uniformly exposed throughout. Ensure that the pavement surface is in proper condition for successful bonding of the pavement markings and provides a neat appearance. Do not leave any loose or flaking existing pavement markings.
- 3) When removing the existing pavement markings, ensure that the finished pavement surface is not damaged or left in a condition that may mislead or misdirect the motorist. Repair any damage to the pavement, pavement joint materials, or the pavement surface caused by the removal of the existing pavement markings in a manner acceptable to the Engineer. After completing these operations, use compressed air to blow clean the pavement surface of residue and debris resulting from the removal of existing pavement markings.
- 4) When removal of existing pavement markings and objectionable materials obscures existing pavement markings of a lane occupied by public traffic, immediately remove the residue, including dust, from the surface being treated. Obtain the Engineer's approval of the removal methods.
- 5) Place the final pavement markings on the same day that the existing pavement markings are removed.
- 6) On concrete surfaces and as the Engineer directs on older asphalt pavements, apply binder to the area where placing pavement marking material.
- 7) On new concrete pavement surfaces, remove the curing compound from the pavement surface before applying the binder and the pavement marking material.

714.03.03 Application.

- A) **Type I Tape.** Apply according to the manufacturer's recommendations. When applied to concrete, cut the tape at all joints.
- B) **Thermoplastic.** Rather than installing thermoplastic pavement markings on fresh asphalt, the Department will allow temporary striping with paint. When choosing this option, cover the temporary striping with the thermoplastic pavement markings within 30 calendar days. The Department will not require

removal of the interim pavement marking paint before applying the thermoplastic pavement markings.

Install the thermoplastic material at a minimum thickness of 90 mils on the pavement surface in a melted state at a temperature from 400 and 440 °F.

Apply additional glass beads by drop-on or pressure spray methods in sufficient quantities to obtain the retroreflectivity requirements specified in Subsection 714.03.06.

Verify the adhesion of the thermoplastic to asphalt pavements by performing bond checks, at least 4 per mile of line, as follows. Approximately 60 to 120 seconds after applying a thermoplastic line to the roadway surface, cut and lift approximately a 6-inch section of thermoplastic. The thermoplastic is successfully bonding to the pavement surface if a layer of asphalt clings to the removed thermoplastic stripe and the pavement surface under the removed stripe is shiny and black.

Provide finished markings that are continuous and uniform in shape, having clear and sharp dimensions. Ensure that all lines have well-defined edges.

714.03.04 Restrictions. Do not apply the pavement marking material when air and pavement temperatures are below 50 °F.

Do not apply the pavement marking material when the surface of the pavement contains evidence of moisture in amounts significant enough to prevent the pavement marking material from bonding to the pavement. Significant amounts of moisture can be caused by heavy dew or very humid nights as well as from rainfall.

If encountering significant amounts of moisture while applying the thermoplastic, the Contractor, at his own risk, may attempt to apply thermoplastic subject to the following restrictions. Heat the thermoplastic material to the upper temperature limit specified by the manufacturer, and apply a test line on the pavement. Perform a bond check according to Subsection 714.03.03. If the thermoplastic successfully bonds to the pavement continue to apply thermoplastic lines, provided there is evidence that the moisture is escaping through the surface of the line, as indicated by very small pin holes. If there is excessive moisture, as indicated by larger sized holes or bubbles on the surface of the line, do not apply thermoplastic until the moisture can be effectively dealt with. Perform a sufficient number of bond checks to ensure that the thermoplastic is bonding to the pavement.

714.03.05 Project Conflicts. When other construction projects are in progress within the limits of the designated work areas, install no pavement markings that will be removed or damaged by immediate subsequent construction. The Engineer will give notification of all conflicting construction projects. Schedule the installation of pavement markings after completion of the conflicting construction. When scheduling is impossible or creates an undue hardship, the Engineer will delete the intersection from this project.

714.03.06 Proving Period for Durable Markings. A 180 day proving period will follow the application of the durable markings. During this period, the Engineer will make such observations as are necessary to determine if the markings are acceptable. The proving period begins when the facility is opened to traffic.

A) Requirements.

- 1) Type I Tape. During the proving period, ensure that the pavement marking material shows no signs of failure due to blistering, excessive cracking, bleeding, staining, discoloration, oil content of the pavement materials, deterioration due to contact with grease deposits, oil, diesel fuel, or gasoline drippings, chipping, spalling, poor adhesion to the pavement, loss of retroreflectivity, vehicular damage, and normal wear. Type I Tape is manufactured off site and warranted by the manufacturer to meet certain retroreflective requirements. As long as the material is adequately bonded to the surface and shows no sign of failure due to the other items listed in

Subsection 714.03.06 A) 1), retroreflectivity readings will not be required. In the absence of readings, the Department will accept tape based on a nighttime visual observation.

- 2) Thermoplastic. During the proving period, ensure that the thermoplastic pavement marking material shows no signs of failure due to blistering, excessive cracking, bleeding, staining, discoloration, oil content of the pavement materials, smearing or spreading under heat, deterioration due to contact with grease deposits, oil, diesel fuel, or gasoline drippings, chipping, spalling, poor adhesion to the pavement materials, loss of retroreflectivity, vehicular damage and normal wear.

The minimum retroreflectivity requirements at the end of the proving period, as measured with a Department approved 30 meter geometry handheld or mobile retroreflectometer, are as follows:

White:	300 mcd/lux/square meter
Yellow:	225 mcd/lux/square meter

The Department will take these measurements between 150 and 210 days after the start of the proving period, with acceptance based on KM 202 or KM 203 as applicable. If the Department determines that the markings are acceptable, the installation of the markings will be considered complete.

- B) **Failure.** During the proving period, the Department will consider markings defective when the retroreflectivity falls below the minimum required or the material fails to meet the other requirements of A) above. Additionally, when more than 10 percent of any one-mile section or individual gore area is defective, the Department will consider the entire section defective. The Department will consider each edge line, centerline, lane line and gore area marking separately.
- C) **Corrective Work.** If a line is found to be defective, repair or remove and replace the line. Perform pavement marking replacement according to the requirements specified in this subsection for the initial application. The corrective work will be subject to a proving period as listed above.

714.03.07 Marking Removal. Remove all markings made in error or not conforming to the traffic operation in use. Do not paint with asphalt binder or other material to obliterate the markings. Remove pavement striping, temporary or permanent, from asphalt or concrete pavement using ultra-high pressure water. Marking removal totaling 1,000 linear feet or less may be removed by an abrasive method to the satisfaction of the Engineer. Vacuum all marking material and removal debris concurrently with the marking removal operation.

Do not damage the pavement in any way and protect all joint seals. If damage is observed, stop the removal process until the operation can provide an acceptable marking removal. Repair any damage to the pavement as a result of the marking removal. Removal of marking will not be measured for payment.

714.03.08 Acceptance of Non-Specification Thermoplastic Markings. When reasonably acceptable work has been produced but retroreflectivity requirements are not met, the Department may accept the work according to Subsection 105.04. When the Engineer determines that the markings may be left in place, the Department will accept them at a reduction in the Contract unit bid price according to Acceptance Pay Schedule for Thermoplastic.

714.04 MEASUREMENT. When a bid item is not included for gore markings, the Department will measure the quantity by converting the actual length and width of line installed to an equivalent length of the normal width line on that section of roadway.

714.04.01 Thermoplastic Pavement Markings. The Department will measure for payment by the units listed in the Quantity Summary. The Department will not measure sampling, testing, surface preparation, pre-marking, interim marking, and binder application for payment and will consider them incidental to the thermoplastic bid items. The Department will not measure corrective work for payment.

714.04.02 Durable Pavement Markings, Type I. The Department will measure for payment by the units listed in the Quantity Summary. The Department will not measure sampling, testing, surface preparation, pre-marking, and binder application for payment and will consider them incidental to the pavement marking bid items. Corrective work will not be measured for payment.

714.04.03 Pavement Striping Removal. When listed as a bid item, the Department will measure for payment by the units listed in the Quantity Summary. The Department will not measure for payment the removal of existing pavement markings that have not been authorized by the Engineer. When the Contract does not list a bid item, the Department will consider existing pavement marking removal incidental to the other pavement marking bid items. The Department will not measure for payment any corrective work required due to the removal work.

714.05 PAYMENT. The Department will make payment upon completion of the work. If after the proving period the markings do not meet minimum retroreflectivity requirements, the Department will adjust the payment or require corrective work according to the following:

ACCEPTANCE PAY SCHEDULE FOR THERMOPLASTIC		
Pay Value	White mcd/lux/square meter	Yellow mcd/lux/square meter
1.00	≥300	≥225
0.50	251-299	176-224
0.25	226-250	151-175
0.00	200-225	125-150
Remove and Replace	< 200	< 125

<u>Code</u>	<u>Pay Item</u>	<u>Pay Unit</u>
06540-06547	Pavement Striping - Thermoplastic, width, color	Linear Foot
06554-06561	Pavement Striping - Durable Type I Tape, width, color	Linear Foot

The Department will consider payment as full compensation for all work required under this section.

SECTION 717 — INTERSECTION MARKINGS

717.01 DESCRIPTION. Furnish and install thermoplastic or Type I tape intersection markings (Stop Bars, Crosswalks, Turn Arrows, etc.) by either a machine applied, screed extrusion process or by applying preformed thermoplastic intersection marking material.

717.02 MATERIALS AND EQUIPMENT.

717.02.01 Preformed Thermoplastic Intersection Marking Material. Select from the Department's List of Approved Materials.

717.02.02 Extruded Thermoplastic Pavement Marking Material. Conform to Section 837.

717.02.03 Binder. Conform to Subsection 714.02.03

717.02.04 Drop On Glass Beads. Use beads that will ensure the pavement marking material will meet retroreflectivity requirements. The Department will evaluate the beads as part of the marking system through retroreflectivity readings.

717.02.05 Extruded Thermoplastic Application Equipment. Provide equipment with a shaping die that simultaneously deposits and shapes lines at a minimum thickness of 90 mils on the pavement surface. Do not use spray and ribbon gun applicators. Ensure the application equipment conforms to the following:

- 1) Capable of providing continuous and uniform heat to maintain the material between 400 and 440 °F throughout the mixing, conveying, and dispensing.
- 2) The kettle is capable of continuous agitation during mixing and heated storage and is equipped with an automatic thermostat control device and material thermometer.
- 3) Equipped with a cutoff device that provides clean, square stripe ends.
- 4) Equipped with an automatic bead dispenser.

717.02.06 Type I Tape. Conform to Section 836.

717.03 CONSTRUCTION.

717.03.01 Layout. On resurfacing, pavement restoration, and pavement rehabilitation projects, prepare and keep a written record of the locations of existing pavement markings, and furnish a copy to the Engineer before removing or obliterating the markings. The Engineer will notify you of any changes to the existing markings.

On new construction, the Department will provide more detailed information for each intersection prior to beginning work. This information will consist of plans, a drawing of each intersection, or an inspector to work with each crew to layout the markings in the field.

Before applying the pavement marking material, pre-mark the pavement surface and obtain the Engineer's approval of the proposed location, alignment, and control guides.

717.03.02 Surface Preparation. Clean all grease, oil, mud, dust, dirt, grass, loose gravel, or other deleterious material from the surface where pavement markings are to be applied as directed by, and by methods acceptable to, the Engineer.

On concrete surfaces and as the Engineer directs on older asphalt pavements, apply binder to the area where placing pavement marking material. Ensure that all solvents have evaporated from the binder before applying the marking material. On new concrete pavement surfaces, remove the curing compound from the pavement surface before applying the binder and the pavement marking material.

717.03.03 Application.

A) Thermoplastic. Install extruded thermoplastic at a minimum thickness of 90 mils on the pavement surface in a melted state at a temperature from 400 and 440 °F. Install preformed thermoplastic according to manufacturer's instructions at a minimum thickness of 125 mils. Apply additional glass beads by a drop-on method at a rate that satisfies the retroreflectivity requirements of Subsection 717.03.05.

When installing symbols and legends (turn arrows, the word "ONLY" etc.) by the extrusion process, ensure that the finished markings conform to the standard size and shape in the Manual on Uniform Traffic Control Devices.

Verify the adhesion of the thermoplastic to asphalt pavements by performing bond checks as follows. Approximately 60 to 120 seconds after applying the thermoplastic material cut and lift approximately a 6-inch section. The thermoplastic is successfully bonding to the pavement surface if a layer of asphalt clings to the removed thermoplastic and the pavement surface under the removed section is shiny and black.

Ensure that finished markings are continuous and uniform in shape having clear and sharp edges with uniform bead distribution across the entire width and length of the line, symbol, or legend.

B) Type I Tape. Apply according to the manufacturer's recommendations. Cut all tape at pavement joints when applied to concrete surfaces.

717.03.04 Restrictions. Do not apply the pavement marking material when air and pavement temperatures are below 50 °F.

Do not apply the pavement marking material when the surface of the pavement contains evidence of moisture in amounts significant enough to prevent the pavement marking material from bonding to the pavement. Significant amounts of moisture can be caused by heavy dew or very humid nights as well as from rainfall.

If encountering significant amounts of moisture while applying the thermoplastic, the Contractor, at his own risk, may attempt to apply the thermoplastic material subject to the following restrictions. Heat the thermoplastic material to the upper temperature limit specified by the manufacturer, and apply a test line on the pavement. Perform a bond check according to Subsection 717.03.03. If the thermoplastic successfully bonds to the pavement continue to apply thermoplastic material, provided there is evidence that the moisture is escaping through the surface of the material, as indicated by very small pinholes. If there is excessive moisture, as indicated by larger sized holes or bubbles on the surface of the material, do not apply thermoplastic until the moisture can be effectively dealt with. Perform a sufficient number of bond checks to ensure that the thermoplastic is bonding to the pavement.

717.03.05 Proving Period. A proving period of 180 days will follow the application of the durable markings. During this period, the Engineer will make such observations as are necessary to determine if the markings are acceptable. The proving period begins when the facility is opened to traffic.

A) Requirements.

1) Thermoplastic. During the proving period, ensure that the material shows no signs of failure due to blistering, excessive cracking, bleeding, staining, discoloration, oil content of the pavement materials, smearing or spreading under heat, deterioration due to contact with grease deposits, oil, diesel fuel, or gasoline drippings, chipping, spalling, poor adhesion to the pavement materials, loss of retroreflectivity, vehicular damage and normal wear.

The minimum retroreflectivity requirements at the end of the proving period, as measured with a Department approved 30 meter geometry handheld retroreflectometer, are as follows:

White: 300 mcd/lux/square meter
Yellow: 225 mcd/lux/square meter

The Department will take these measurements between 15 and 45 days after the start of the proving period, with acceptance based on KM 201. If the Department determines that the markings are acceptable, the installation of the markings will be considered complete.

- 2) **Type I Tape.** During the proving period, ensure that the pavement marking material shows no signs of failure due to blistering, excessive cracking, bleeding, staining, discoloration, oil content of the pavement materials, drippings, chipping, spalling, poor adhesion to the pavement, loss of retroreflectivity, vehicular damage, and normal wear. Type I Tape is manufactured off site and warranted by the manufacturer to meet certain retroreflective requirements. As long as the material is adequately bonded to the surface and shows no signs of failure due to the other items listed in Subsection 714.03.06 A) 1), retroreflectivity readings will not be required. In the absence of readings, the Department will accept tape based on a nighttime visual observation.
- B) **Failure.** The Department will consider any marking defective when the readings for that marking do not satisfy the retroreflectivity requirements or more than 10 percent of the material fails to meet the other requirements of A) above. The Department will consider each marking separately.
- C) **Corrective Work.** If any marking is found to be defective, repair or remove and replace the marking. Perform pavement marking replacement according to the requirements specified in this subsection for the initial application. The corrective work will be subject to a proving period as listed above.

717.03.06 Marking Removal. Remove all markings made in error or not conforming to the traffic operation in use. Remove markings by water blasting process to the satisfaction of the Engineer. Vacuum all marking material and removal debris concurrently with the removal operation. Do not paint with asphalt binder or other material to obliterate the markings.

A) Waterblast Stripe Removal. Conform to subsection 713.03.04.

717.03.07 Acceptance of Non-Specification Markings. When reasonably acceptable work has been produced but retroreflectivity requirements are not met, the Department may accept the work according to Subsection 105.04. When the Engineer determines that the markings may be left in place, the Department will accept them at a reduction in the Contract unit bid price according to Acceptance Pay Schedule for Thermoplastic. The Department will not consider these procedures a means to continue accepting non-specification markings.

717.04 MEASUREMENT. The Department will measure the intersection markings on a per unit basis for items listed in the Quantity Summary.

The Department will not measure the removal of existing markings, layout, surface preparation, binder, glass beads, or testing for payment and will consider them incidental to the installation of the new marking. The Department will exclude the gaps when measuring dotted lane line extensions.

717.05 PAYMENT. The Department will make payment for the completed and accepted quantities under the following:

ACCEPTANCE PAY SCHEDULE FOR THERMOPLASTIC		
Pay Value	White mcd/lux/square meter	Yellow mcd/lux/square meter
1.00	≥300	≥225
0.50	251-299	176-224
0.25	226-250	151-175
0.00	200-225	125-150
Remove and Replace	< 200	< 125

<u>Code</u>	<u>Pay Item</u>	<u>Pay Unit</u>
06565, 06566	Pavement Marking, Thermoplastic X-Walk, Size	Linear Foot
06567, 06568	Pavement Marking, Thermoplastic Stop Bar, Size	Linear Foot
06569	Pavement Marking, Thermoplastic Cross Hatch	Square Foot
06572	Pavement Marking, Dotted Lane Extension	Linear Foot
06573-06575, 06578	Pavement Marking, Thermoplastic Arrow, Type	Each
06576	Pavement Marking, Thermoplastic "ONLY"	Each
06577	Pavement Marking, Thermoplastic "SCHOOL"	Each
06563	Pave Marking – R/R X Bucks 16 IN	Linear Foot
20782NS714	Pave Marking Thermo – Bike	Each
23251ES717	Pave Mark TY I Tape X-Walk, Size	Linear Foot
23264ES717		
23252ES717	Pave Mark TY I Tape Stop Bar, Size	Linear Foot
23265ES717		
23253ES717	Pave Mark TY I Tape Cross Hatch	Square Foot
23254ES717	Pave Mark TY I Tape Dotted Lane Extension	Linear Foot
23255ES717	Pave Mark TY I Tape Arrow, Type	Each
23268ES717-23270ES717		
23256ES717	Pave Mark TY I Tape- ONLY	Each
23257ES717	Pave Mark TY I Tape- SCHOOL	Each
23266ES717	Pave Mark TY 1 Tape R/R X Bucks-16 IN	Linear Foot
23267ES717	Pave Mark TY 1 Tape-Bike	Each

The Department will consider payment as full compensation for all work required under this section.

**DISTRICT WIDE STRIPING
CONTRACTS**



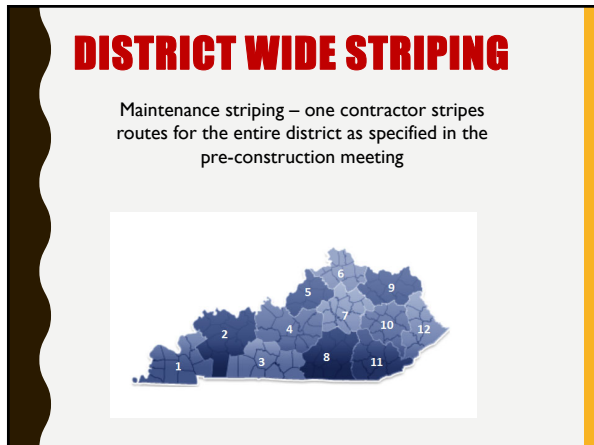

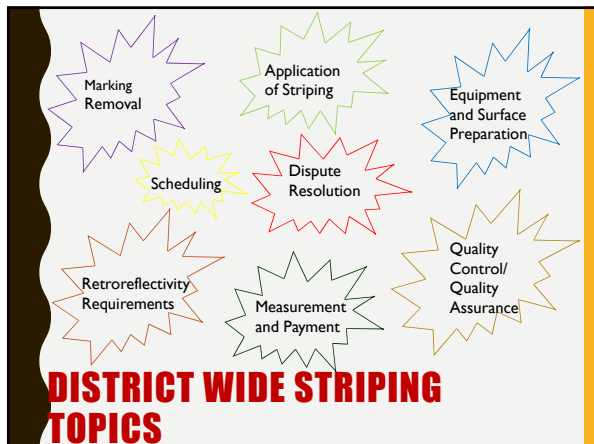

EQUIPMENT AND SURFACE PREPARATION

- **Electrical counter**
 - Tabulate the amount of footage applied by each striping gun
- **Data logger system – recorded in 1 mile increments**
 - Gallons of paint per mile
 - Average wet film thickness
 - Pounds of beads per gallon of paint
 - Ambient temperature
 - Pavement temperature
 - Paint temperature
 - Store the calibration parameters
 - Remote cab mounted display indicating parameters in real time



EQUIPMENT AND SURFACE PREPARATION

- **Sweeping Unit**
 - Remove dirt and debris
 - Shall not be a part of the striper
 - Broom must maintain contact with the roadway



EQUIPMENT AND SURFACE PREPARATION

- **KM 64-267**
 - Stripers available at a central location for inspection
 - Stripers pre-approved prior to striping
 - Random field verifications



QC/QA REQUIREMENTS

- **Quality Control Coordinator (QCC)**
 - Designated by the contractor
 - Performs Quality Control (QC) Inspection
- **Quality Control Plan (QCP)**
 - Furnished and approved prior to the start of work
- **Quality Assurance Inspector (QA)**
 - Designated by the state
 - Performs QA Inspection



QCC COORDINATOR

- Hold qualification as a Pavement Marking Inspection Technician
- Oversee contractor's evaluation of applied lines
- Notify Engineer of changes to the striping application process
- Submit Daily Striping Reports to Engineer the next calendar day



QCC COORDINATOR CONT.

Ensure the Data Logger System (DLS) manufacturer makes available to the Engineer electronic DLS raw data from the secure server at any time.

“Provide GPS mapping system that is capable of real time (within 20 minutes) tracking of material application rates, film thickness, beads pounds per gallon, vehicle speed time, date, project numbers, operator manual data, and color coded alarms for film thickness. Film thickness must have a tolerance of ± 0.5 mils.”

QCC COORDINATOR (CONT.)

- Inform/mobilize crews to complete restriping or corrective work
- Supply certifications at the time of sampling
- Track quantities of materials
- Meet with the Engineer to conduct field reviews
- Coordinate and review/perform KM202 and provide electronic test reports to the Engineer within one (1) working day
 - Failure to provide printouts: section not accepted and corrective work must be performed



QUALITY CONTROL PLAN

- Identifies QC Coordinator and other Pavement Marking Inspection Technicians
 - Names and addresses
 - Phone and fax numbers
- Work Plan
 - Starting and completion dates
 - Number of crews
 - General description of how the project will be completed



QUALITY CONTROL PLAN (CONT.)

- Description of striping equipment
 - Make and model of each striper
 - Minimum and maximum operating speeds
 - Instruments used to calibrated flow of paint and beads
- Frequency and method of monitoring application rates and quality of line
- Materials list
 - List of paint and beads
 - Manufacturer's recommendations for application

QUALITY CONTROL PLAN (CONT.)

- Contact person for paint on vehicle claims
 - Email
 - Phone and fax numbers
- Description and product literature for reflectometers to be used on the project
- Submit manufacturer's sampling procedure for sampling from tote

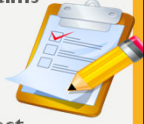

QA INSPECTOR

- Perform testing on at least one segment of each section for verification of QC testing
 - Provide QCC with randomly selected zones on the day QC testing is to be performed
 - Randomly select at least one segment for QA verification testing
 - Test in accordance with KM202
 - QA should perform verification testing within the 30-60 calendar days of application or within two weeks of receiving QC report



DISPUTE RESOLUTION

Base payment on QCC's results if QC and QA mean values differ by less than 10%



DISPUTE RESOLUTION

1. Do the QC and QA results differ by more than 10% within a segment and indicate a change in pay?

- Additional readings are required
- Discard original QC and QA test results for the section
- QA will randomly establish 3 new zones in each segment of the section
- QC and QA will jointly evaluate each new zone within the section
- Accept QC test results if the mean values differ by less than 10%



DISPUTE RESOLUTION

2. Do the QC and QA results differ by more than 10% but there is no change in pay?

- Additional Readings will not be required
- Accept the QC test results
- Determine the cause of the discrepancy
- Document resolution to the discrepancy



DISPUTE RESOLUTION



3. Can a resolution not be achieved by the QC and QA?

- Additional testing within 2 weeks of written request
- Three (3) new zones in each segment of the section
- Calibrate QC, QA and CO instruments
- Accept QC: QC < 10% to CO
- Accept QA: QC > 10% to CO and QA < 10% to CO
- Accept CO: QC and QA > 10% to CO

DISPUTE RESOLUTION

- Contractor will incur all costs associated with dispute resolution that does not result in use of QC test data for payment
- Department reserves the right to take over the QC portion of testing; the contractor will incur the cost of testing performed by the Department



DISPUTE RESOLUTION

- Vendor evaluating markings by KM203 must demonstrate compliance to quality control procedures
 - Department will select test site
 - Joint evaluations conducted for both white and yellow markings
 - Vendor deemed compliant if mean averages differ by less than 10% for each marking
 - Payment for evaluation by KM203 will be based solely on the Department's approved vendor



APPLICATION OF STRIPING

- Paint must be applied in a single pass at an application rate in accordance with Section 713.03.03
- No bead application rate
- Contractor responsible for protecting paint line



APPLICATION OF STRIPING

- Complete all striping in a county for each type of paint before striping in another county
 - 4" Yellow
 - 4" White
 - 6" Yellow
 - 6" White
- All striping in a section must be completed within one week

APPLICATION OF STRIPING

- Engineer may stop the striping operation for unsatisfactory quality including but not limited to
 - Retroreflectivity
 - Bead distribution
 - Paint thickness
 - Overspray
 - Accuracy of retracing
 - Line width
 - Consistency
 - Tracking

CLEANING OF APPLIED STRIPE

- May clean prior to QC testing
- Cleaning – single pass using a broom truck
- Notify the Engineer 48 hours prior to performing cleaning operations

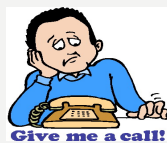

MARKING REMOVAL

- Water blasting only
- Begin corrective within 5 working days and work continuously



RETROREFLECTIVITY REQUIREMENTS

- **Section 713**
 - White: 300 mcd/m²/lux
 - Yellow: 225 mcd/m²/lux

SCHEDULING DEADLINES

- Priority routes– June 1, 2019
- Additional routes added by– July 1, 2019
- Scheduled routes–August 15, 2019
- Re-Striping– October 15, 2019
- Continue re-striping – spring of 2020 until June 1, 2020
- Re-Striping – October 15, 2020

- Re-stripe -completed within 15 calendar days of notification by the Engineer after that it will accrue liquidated damages until October 15, 2019
- The Engineer can require that re-stripe not completed by October 15, 2019 be completed as a priority route in the following spring by June 1, 2020
- Re-stripe not completed June 1, 2020 will accrue liquidated damages until October 15, 2020
- If a section is not accepted, the entire section must be re-striped

RE-STRIPE



ADDITIONAL TESTING COSTS

- Cost of re-testing by KM203 shall be reimbursed to the Department by the contractor
- Costs associated with additional testing for dispute resolution shall be incurred by the contractor if the QC results are not used for payment



MEASUREMENT AND PAYMENT

- **Initial payment**
 - 50% upon application of stripe
- **Final payment**
 - Section is accepted – 50%
 - Section is not accepted – required restripe



**SPECIAL NOTES FOR WATERBORNE PAINT STRIPING
AND DURABLE WATERBORNE PAINT STRIPING
2019 DISTRICT WIDE CONTRACTS**

DESCRIPTION

Except as specified herein, perform all work according to the Commonwealth of Kentucky, Transportation Cabinet, Department of Highways' 2012 Standard Specifications for Road and Bridge Construction; Supplemental Specifications; applicable Standard and Sepia Drawings; applicable Special Notes and Special Provisions; and Kentucky Methods; current editions. Section references are to the Standard Specifications.

SCOPE OF WORK

Furnish and apply waterborne striping paint for 4 inch lines and durable waterborne striping paint for 6 inch lines, reflectorized with glass beads, to the sections of roadway provided in this Contract with an updated listing provided at the pre-construction meeting. This Contract is for the installation of centerlines, lane lines, edgelines, ramp lines, dotted lines and gore markings only. Gore marking materials shall be the same as the mainline of the roadway. Special markings such as stop bars, crosswalks, cross-hatching, railroad markings, etc. are not to be installed under this Contract.

Intersection approach markings such as the edgelines of large painted islands or edgelines on mountable medians may be included at the discretion of the Engineer provided they can be painted by the striping truck. Markings that would require application by equipment other than the striping truck are not to be installed under this Contract.

Retrace existing lines on the listed routes. The Department will pre-mark any section of roadway where there are no existing markings, old markings are no longer visible, or where the existing markings are to be changed. Do not place edge lines on any section of roadway where edgelines do not currently exist without written authorization from the Chief District Engineer.

MATERIALS FOR WATERBORNE AND DURABLE WATERBORNE PAINT STRIPING

PAINT: Furnish paint materials for this project to meet the performance requirements detailed in Sections 842 and 846 of the Standard Specifications, except that yellow composition shall have a contrast ratio at 15 mils wet film thickness of 0.980.

Submit initial samples for each paint formulation for approval prior to initiation of the striping operation. The Contractor's paint manufacturer may submit the initial sample directly to the Department. The Department will obtain subsequent samples of paint in accordance with the

Waterborne & Durable Waterborne Paint Striping Page 2 of 13

Materials Field Sampling Manual when striping operations are in progress. A minimum of one sample will be obtained per color, per truck, per week and shall represent the quantity of striping applied per week. Deductions for application of non-specification paint shall be assessed to the quantity of striping represented by the sample.

BEADS: Use sufficient beads to ensure the pavement marking material meets retroreflectivity requirements. The Department will evaluate beads as part of the installed pavement marking in accordance with Kentucky Method 202 or 203 as applicable. Testing of the coatings, gradation and quality of the product applied shall be the responsibility of the Contractor.

MATERIALS SAMPLING AND ACCEPTANCE

If two or more random samples obtained during striping operations fail to meet minimum compositional requirements, striping operations shall be discontinued at the discretion of the Engineer. In the event striping operations are discontinued, the Department will randomly sample and test each batch of paint the Contractor has in stock at the storage location.

For batches of paint that fail to meet the minimum compositional criteria, the stock material will be rejected. The Contractor will be required to remove all failing paint from his central storage location. Batches that are tested and found to be in compliance with the compositional requirements may be used. After the Department has sampled all of the material at the central storage area, sampling and testing will resume according to the Materials Field Sampling Manual as soon as striping operations resume.

A deduction in payment will be made for any paint used that fails to meet material requirements according to Sections 842 and 846 as applicable.

EQUIPMENT

Each striper shall be equipped with electrical foot counters. The counters shall individually tabulate the amount of footage applied by each striping gun on the carriage, whether solid or dashed. The counters shall be capable of measuring up to six digits and shall have a reset feature. The counters shall be calibrated in the presence of a Department representative to insure an accurate measurement of the paint applied. Perform the calibration prior to starting striping operations and as necessary thereafter. When done, the Department's representative will record the calibrations on the Engineer's Daily Work Report (DWR).

Each striper shall be equipped with an accurate dashing mechanism, capable of being adjusted to retrace existing lane line, dotted lines or centerline markings as directed by the Engineer. The striper shall also be equipped with a detection device that will automatically cutoff the paint guns when a raised or recessed pavement marker is detected in the pavement. The Contractor, at his own expense, shall replace or adequately clean any pavement marker lens that is painted.

Waterborne & Durable Waterborne Paint Striping Page 3 of 13

Equip each striper with a Data Logging System (DLS) that will record operational details during striping operations, store data, and generate and export reports on a daily basis to the manufacturer's secure server. Provide only DLS equipment certified by the manufacturer. Ensure the data is in Microsoft Excel format, or a comma or spaces delimited text file adequate for insertion into a computerized spreadsheet. The DLS shall monitor and report the quantities of paint and beads consumed in line and calculate, in real time, the gallons of paint per mile, average wet film thickness, and pounds of beads per gallon of paint for each line application. The DLS shall monitor and report the ambient temperature, pavement temperature, and paint temperature, and record the data at the beginning of each line application and at a minimum of 1 mile increments during application. The DLS shall be capable of storing and supplying the necessary scaling and calibration parameters to the flow meters, and shall provide a means of adjusting the scaling factor as necessary. The DLS shall include a remote cab mounted display, which shall indicate in real time, pavement temperature, application rate of paint in gallons per mile, paint film thickness in mils, and application rate of beads in pounds per gallon. In addition the Contractor's striper shall also be equipped with a calibrated measuring device for monitoring quantities of paint and beads consumed in line.

Export to the secure server a DLS report as raw data, and as an Excel spreadsheet containing the following information: route; the beginning and ending mile points; the beginning and ending coordinates determined by a Global Positioning System receiver with a 16 foot accuracy, and the direction of travel; line type, indicated as CL (Yellow Center Line Double-Solid, Mono-directional passing, or Bi-directional passing); EL (White Edge Line on all roads or Yellow Edge Line on Solid Median Multi-Lane Highways and Interstates); LL (Solid Yellow or White Lane Line to define turn or merge lanes); SK (Dashed Yellow or White Line 10'stripe/30'gap); GM (Gore Marking installed at 2x the Edge Line Width); DTLE (Dashed Yellow or White Line Extension 3'stripe/9'gap); line width; line color; direction of application (this must be indicated for each direction travelled i.e. must include a separate entry for both the North and South directions, cannot be one entry that says direction was North/South); weight of paint applied in pounds or number of strokes counted, appropriate scaling factors; paint film thickness in mils; paint application rate in gallons per mile; bead application rate in pounds per gallon; paint temperature obtained immediately after the heat exchanger; ambient temperature; pavement temperature; and vehicle speed in miles per hour. Report application and temperature data in one-mile increments for each line applied. Provide GPS mapping system that is capable of real time (within 20 minutes) tracking of material application rates, film thickness, beads pounds per gallon, vehicle speed, time, date, project numbers, operator manual data, and color coded alarms for film thickness. Film thickness alarms must have a tolerance of ± 0.5 mils.

Provide access to stored data on a secure password protected website. The Department reserves the right to obtain any and all raw data recorded by the DLS at any time during this Contract. The Engineer may require field verification of the DLS operation and calibration at any time to ensure the accuracy of the DLS data and output. If field personnel suspect that the DLS data and/or output are not accurate, the Engineer may direct additional checks be performed.

Waterborne & Durable Waterborne Paint Striping Page 4 of 13

The secure server shall allow the Department to be able to create a Daily Striping Report which automatically fills from the DLS's data. It shall auto-populate all fields shown on the attached DSR except for Route Type, Mobile, and Corrective Re-stripe. These fields will be drop downs to be chosen by the user. The route length shall be calculated from the GPS data and not the manually entered milepoints. The DSR shall compute the total striped line length in "Totals Summary" once the user picks the "Route Type."

Prior to starting striping operations, make all strippers available at a central location within Kentucky designated by the Department for inspection by the Department for compliance to Kentucky Method 64-267 and DLS requirements. Striping trucks that can fulfill the requirements of this method and these notes will be approved for use on this Contract. Striping trucks that have not been approved for use by Department personnel will not be allowed to stripe as part of this Contract. The Department reserves the right to perform random field verifications of striping equipment during this Contract.

The Engineer may require the Contractor to provide detailed operating instructions from the manufacturer of the striping equipment and/or the DLS if quality or reporting issues arise at any time during the Contract. The Contractor shall then be required to operate the striping equipment within the suggested operating guidelines of the manufacturer, with particular emphasis on the speed of the striping operation, or make other adjustments until the quality of the striping is satisfactory to the Engineer.

The Contractor shall provide a separate sweeping unit powerful enough to remove normal highway dirt and debris. This unit shall not be a part of the stripper.

CONSTRUCTION

Except as specified herein apply all striping according to Section 713.

SURFACE PREPARATION

Prepare the pavement surface for the striping operation in accordance with Section 713.03.02. Sweep all pavement surfaces prior to striping and maintain the cleaning operation far enough in advance of the striping operation to prevent any dust from the cleaning operation from mixing with the paint. The sweeper must maintain contact with the roadway. When the Engineer determines abnormal amounts of debris or other material have accumulated beyond the capability of the required sweeping unit which will require shoveling or other means to remove, the Engineer will make arrangements, prior to painting, to have the material removed by the Department or that section of roadway will be deleted from the Contract.

Waterborne & Durable Waterborne Paint Striping
Page 5 of 13

QUALITY CONTROL (QC) and QUALITY ASSURANCE (QA)

The Contractor shall designate a Quality Control Coordinator (QCC) for the project who will be the contact person for any questions or concerns regarding the quality of the work performed under this Contract. The QCC shall:

- Hold current qualification from the Department as a Pavement Marking Inspection Technician;
- Plan and oversee the Contractor's evaluation of the lines applied on the project;
- Complete and submit Daily Striping Reports to the Engineer within 24 hours of completion of that days striping;
- Ensure that the DLS manufacturer submits electronic DLS raw data and Excel spreadsheets from the secure server by e-mail, at the e-mail addresses provided at the preconstruction meeting, to designated field personnel no later than the first working day following application of the pavement markings.
- Verify the electronic records are completed and received by the Engineer prior to the records being removed from the pavement marking equipment.
- Coordinate and review or Perform KM-202, for each section of striping and provide completed test reports (electronic copy) along with printouts from the handheld retroreflectometer to the Engineer within one (1) working day of completion (failure to provide the printouts will cause the Department to not accept that section and require corrective work in order to be eligible for the final 50% payment);
- Document all adjustments made to the application process to consistently produce the quality of line desired;
- Notify the Engineer of any changes in the striping work plan that are determined necessary
- Inform and mobilize crews to complete restriping or corrective work (after notification by the Department);
- Supply the appropriate certifications for paint and the DLS to the Engineer assigned to the particular project at the time of sampling;
- Track the quantities of materials supplied by the Contractor's vendors and applied by the painting crew;
- Meet with the Engineer to discuss and/or conduct field reviews on the project throughout the execution of the Contract;
- Perform QC testing in accordance with KM-202 for each section of striping on zones selected by the Department based on KM-64-113 The Department will **NOT** provide advanced notice of the randomly selected zones to the Contractor prior to the striping being placed, but will only provide the locations for each randomly selected zone on the day of the test. The Department's QA inspector will coordinate the date of the test with the Contractor's QCC.

Waterborne & Durable Waterborne Paint Striping Page 6 of 13

At the Pre-construction Conference, the Contractor shall furnish the Department for approval a Quality Control Plan (QCP) that covers in detail the following items:

- The name, address, phone and fax numbers for the QCC;
- The names of individuals other than the QCC taking readings in accordance with KM-202 (these people shall hold qualification from the Department as Pavement Marking Inspection Technicians);
- An overall work plan which states the estimated starting and completion dates for the entire project, the number of crews to be used on the project and a general description of how the project will be completed;
- A description of the striping equipment to be used on the project, including make and model of each striper, minimum and maximum operating speeds, and type of instruments to be used to calibrate the flow of paint and beads;
- The frequency and method to be used to monitor application rates and quality of the line (specifically with regard to retroreflectivity, width, thickness, bead distribution, tracing accuracy, etc.);
- A list of paint(s) and bead(s) to be used in this Contract along with a statement from the paint manufacturer that indicates the recommended minimum and maximum application temperatures for ambient temperature, pavement temperature, paint temperature, and guidelines for any other environmental factors that would adversely affect the successful performance of the paint;
- The contact person, phone, e-mail and fax numbers for reporting claims for paint on vehicles
- A description and product literature of the reflectometer to be used by the Contractor;
- A description, product literature, and manufacturer's certification of the DLS to be used by the Contractor;
- The manufacturer's sampling procedure for sampling paint from the tote.

Obtain the Engineer's acceptance of the Contractor's QCP prior to the start of work. The Department reserves the right to require the Contractor to make changes in the QCP to obtain the quality specified in the Contract.

After acceptance by the Department, the Contractor shall notify the Engineer in writing of any proposed change(s) to the QCP. Proposed changes are subject to acceptance by the Department.

The Department will perform Quality Assurance (QA) testing on (at least) one segment of each section of striping completed by the Contractor. QA testing is intended to verify the Contractor's QC test data. Upon receipt of the Contractor's QC test reports for each section, the QA Inspector will randomly select (at least) one segment for QA evaluation. The Department will **NOT** provide advance notice to the Contractor of the selected segment. The Department will perform the test in accordance with KM-202 with the exception that QA testing will be conducted within the later of 30-60 calendar days after the striping application or 2 weeks of receipt of the Contractor's QC report.

Waterborne & Durable Waterborne Paint Striping
Page 7 of 13

The Department will base payment for each section evaluated in accordance with KM-202 on the Contractor's QC test results if the QC and QA mean values for each segment selected for QA testing differ by less than 10% of the QA mean value.

If a dispute should arise regarding the acceptability of the Contractor's QC test results the dispute resolution shall be conducted as follows:

1. If the retroreflectivity values obtained during the QA testing within a segment indicate a change in pay quantities (i.e. QC readings are passing and QA readings are failing) and the mean values differ by more than 10% of the QA mean value; additional testing will be required. Discard the original QC and QA test results for the section in question. The QA will randomly establish three new zones, in accordance with KM-113, in each segment within the section in question. The QC and QA will jointly evaluate each new zone within the section in accordance with KM-202 (with the exception of the evaluation period if greater than 60 days). The QC test results for each segment will be used for evaluation of the section if the QC and QA mean values for each segment differ by less than 10% of the QA mean value.
2. If the variance between QC and QA testing does not indicate a change in the pay quantities for the section (i.e. QC and QA readings are both passing) however, the QC mean values differ by more than 10% of the QA mean value, additional readings will not be required. Accept the QC test results for evaluation of the section. However, additional testing within the section in question should be conducted as soon as possible to determine the cause of the discrepancy. The Contractor and the Engineer shall document the resolution to the discrepancy.
3. If resolution to a dispute or variance of QC and QA test results cannot be achieved by the QC and QA, additional testing will be required. Discard the QC and QA test results for the section in question. Additional testing will be conducted by the QC, QA, and representatives of Central Office Division of Materials. Additional testing will be conducted within two weeks of receipt of a written request from the Engineer to the Division of Materials for each section in question. Three new zones, randomly selected in accordance with KM-113, will be established by the QA for each segment of the section in question. Each instrument to be used for testing will be calibrated in the presence of Central Office representatives prior to initiation of testing. The QC, QA and Central Office representatives will obtain readings for each new zone in accordance with KM-202 (with the exception of the evaluation period if greater than 60 days). The QC test results for each segment will be used for evaluation of the section if the QC mean values for each segment differ by less than 10% to the mean value obtained by Central Office. The QA test results for each segment will be used for evaluation of the section if the QC mean values differ by more than 10% to the mean value obtained by Central Office and the QA mean value differs by less than 10% to the Central Office mean value. If neither the QC nor QA mean values meet these requirements, the Central Office mean value for each segment will be used to evaluate the section in question. These results will be final and the basis of payment for the section in question.

Waterborne & Durable Waterborne Paint Striping Page 8 of 13

The Contractor shall incur all costs associated with additional testing performed by Department personnel for dispute resolution that does not result in the use of QC test data as the basis of payment. These costs will include the cost to maintain and control traffic.

The Department reserves the right to take over the QC portion of testing. In the event that the Department exercises this option, the Contractor will incur the cost of testing performed by the Department.

The Department reserves the right to evaluate retroreflectivity on designated routes, in whole or in part, in accordance with KM-203. The Department will identify routes or portions of routes to be evaluated in accordance with KM-203. The evaluation of a section in accordance with KM-203 will be conducted at the Departments expense.

The Department will require the Department's approved vendor performing retroreflectivity evaluation in accordance with KM-203 to successfully demonstrate compliance to his/her quality control procedures prior to collection of data for this Contract. The Department will select an appropriate test site for demonstration purposes and conduct joint evaluations of both yellow and white longitudinal markings within the test site using approved 30M geometry handheld instruments. The demonstration will be deemed successful if the mean average obtained by the approved vendor differs by less than 10% to the mean average obtained by the Department for each marking evaluated within the test site.

The Department will base payment for each section evaluated in accordance with KM-203 solely on the test results obtained by the Department's approved vendor. Completed test results submitted by the Department's approved vendor will be considered final and are not subject to dispute.

The Department will furnish the Contractor with a blank electronic copy of the Contractors Daily Striping Report (DSR). The Contractor shall complete and furnish this standard DSR to the Engineer's office **the next calendar day** for each crew for each color and width of line applied. The information on the DSR shall reflect the milepoints and quantities for striping completed for that day and for that crew. The Contractor shall also include with the DSR the certification for the paint used on that day's striping according to Section 842.05 and 846.05, as applicable.

Export DLS reports **each calendar day** to the manufacturer's secure server. Ensure that the DLS manufacturer submits electronic DLS raw data and Excel spreadsheets from the secure server by e-mail, at the e-mail addresses provided at the preconstruction meeting, to the designated field personnel no later than the first working day following application of the pavement markings. Verify the electronic records are completed and received by the Engineer prior to the records being removed from the pavement marking equipment.

Waterborne & Durable Waterborne Paint Striping
Page 9 of 13

APPLICATION OF STRIPING

Roadways shall be marked with 4", 6", 8" and 12" lines as indicated in the summaries and/or as directed by the Engineer. The four-inch line shall be not less than four inches nor more than five inches in width. The six-inch line shall be not less than six inches nor more than seven inches in width. The centerline of all newly applied lines shall be within one inch of the centerline of the existing stripe. Mark all Interstate and Parkway System Routes and other routes listed on the summaries for 6 inch striping using Durable Waterborne Paint meeting the requirements of Section 846, except as specified herein. Mark all other routes with four-inch lines using Waterborne Paint meeting the requirements of Section 842, except as specified herein. Apply Gore area markings at twice the width of the normal line width on that portion of roadway. All lines shall have distinct, clean edges with proper bead distribution across the entire width and length of the line.

Passing zones and lane lines shall be installed as a 10' segment of paint with a 30' gap. The length of the 10' segment shall not be less than 10' nor longer than 10 feet 6 inches. The stripe-gap cycle shall be not less than 39 feet 6 inches and no longer than 40 feet 6 inches.

Apply paint, in a single pass, in accordance with the application rates in Section 713.03.03. Contrary to Section 713.03.03, the Contractor may apply beads at any application rate that meets the retroreflectivity requirements of Section 713.03.05.

The Contractor shall be responsible for protecting the painted line from traffic until dry in order to eliminate tracking. Retroreflectivity readings will be taken on zones with substantial amounts of tracking and the readings will be used in the calculation of payment. If the Contractor elects to use additional traffic control devices beyond what is specified in the TRAFFIC CONTROL PLAN, the additional cost shall be incidental to the bid item "Maintain and Control Traffic".

If the Engineer determines that the quality of the striping applied by the Contractor is unsatisfactory with regard to retroreflectivity, bead distribution, paint thickness, overspray, accuracy of retracing, line width, consistency, tracking, etc., the Engineer may stop the striping operation immediately until the Contractor can demonstrate that the problem has been corrected. If it is determined by the Engineer that the striping is not applied at the specified application rate, restriping will be required.

CLEANING OF APPLIED STRIPING

The Contractor has the option to clean accumulated debris from affected route prior to performing QC testing. Cleaning is defined as a single pass using the broom truck to remove accumulated debris from the affected striping. Notify the Engineer 48 hours prior to performing the cleaning operations.

Waterborne & Durable Waterborne Paint Striping
Page 10 of 13

MARKING REMOVAL

The Contractor shall be responsible for all necessary cleanup of any paint or other material that is spilled onto the pavement or elsewhere as a result of his operations and for correcting any striping error (including tracking and rain damage) that the Engineer determines removal to be required. Contrary to Section 713.03.04, remove all striping errors or paint spills by water blasting only (see attached note) at no additional cost to the Department. This removal process shall be performed in a manner that shall not be detrimental to the pavement. Upon notification of a striping error or paint spill by the Engineer, the Contractor shall be required to begin the process of correcting the striping error or paint spill within five (5) working days and shall work continuously to complete the corrective work prior to striping any other section of roadway included in this Contract.

Prior to retracing, the Engineer will notify the Contractor if existing striping errors need to be removed. Contrary to Section 713.03.04, remove all existing striping errors by water blasting only (see attached note). The Department will measure and pay for water blasting removal of existing stripes directed by the Engineer in linear feet.

PAINT ON VEHICLES

The Contractor shall be responsible for addressing disputes with the public regarding paint on vehicles that occur as a result of his operations. All complaints from the public shall be addressed in a timely manner and the Contractor must demonstrate a “good faith” attempt to resolve disputes to the satisfaction of the citizen. However, the Contractor shall have the right to dispute fault and refuse settlement in cases where the Contractor feels that paint on the vehicle was a result of negligence on the part of the citizen. Unresolved disputes involving paint on vehicles shall be handled through the legal system. The Department shall not be held responsible for paint on vehicles under any circumstances.

RETROREFLECTIVITY REQUIREMENTS

The minimum retroreflectivity requirements shall be in accordance with Section 713.03.05A of the Standard Specifications.

Restriping will be required for striping that fails to meet the minimum retroreflectivity requirements. The provisions for restriping are described in the section of this Contract entitled MEASUREMENT AND PAYMENT. Complete the restriping within 15 calendar days after notification by the Engineer except that restriping will be suspended after **October 15, 2019** until the following spring at the discretion of the Engineer. All re-striping not completed by **October 15, 2019** will be re-striped at the Engineer’s discretion as a priority route in the spring of 2020 and completed by **June 1, 2020**. All aspects of this specification shall apply to lines that are repainted due to failure to meet the requirements of this specification including the retroreflectivity requirements.

Waterborne & Durable Waterborne Paint Striping
Page 11 of 13

SCHEDULING

At the Pre-construction conference, the Engineer may provide the Contractor with a list of Priority Routes (not to exceed 10 percent of the total project estimate) which are to be striped prior to **June 1, 2019**. The painting of all scheduled routes shall be completed by **August 15, 2019**.

The Contractor shall coordinate the daily striping schedule, one week in advance, with the Engineer. **Unless approved by the Engineer, complete all striping in a county, for that type of paint, before starting striping for that type of paint in another county (for this Contract there are four types of paint striping: 4" yellow, 4" white, 6" yellow, and 6" white).** The Contractor shall ensure that once striping begins on a section that ALL striping on that section must be completed within **one** week. Failure to comply with this requirement will result in withholding of pay estimates.

The Engineer may eliminate any route from the schedule at any time prior to striping if it is determined that the route does not require retracing. Also, the Engineer may add additional routes to be striped. The Contractor shall be notified of added routes prior to July 1, 2019.

CONTRACT COMPLETION AND LIQUIDATED DAMAGES

All priority routes shall be striped by June 1, 2019. Contrary to the Standard Specifications, no time extension will be granted for failure to complete striping of these priority routes by the June 1, 2019 milestone completion date. Liquidated damages in the amount specified in Section 108.09 of the Standard Specifications will be assessed for each day that any priority route remains unstriped after June 1, 2019.

Sections that are required to be re-striped due to failure to meet retroreflectivity requirements must be completed within 15 calendar days after notification by the Engineer. The Department will assess Liquidated Damages in the amount specified in Section 108.09 of the Standard Specifications for each day beyond the 15 calendar days that the restriping is not completed and shall accrue until October 15, 2019. Failure to complete all necessary corrective work by the October 15, 2019 deadline will result in no additional payment for the stripe beyond the 50% that was initially paid for the installation of the stripe and payment will be based upon the Payment Schedule. **At the Engineer's discretion, necessary corrective work not completed by the October 15, 2019 deadline may be required to be re-striped in the spring of 2020 as a priority route with a completion date of June 1, 2020. Any re-stripe required by the Engineer that is not completed by June 1, 2020 shall accrue liquidated damages until October 15, 2020.**

All routes that are required to be striped under this Contract shall be completed by **August 15, 2019**. Contrary to the Standard Specifications, no time extension will be granted. Liquidated damages will apply in accordance with Section 108.09 of the Standard Specifications for failure to complete the striping by **August 15, 2019**. Liquidated damages will accrue until October 15, 2019; no striping shall be performed after this date.

Waterborne & Durable Waterborne Paint Striping
Page 12 of 13

Remove all striping errors and spills within five (5) working days after notification by the Engineer. Liquidated damages, in the amount specified in Section 108.09 of the Standard Specifications, shall apply for each day beyond the five (5) working days that the Contractor has not begun to correct the striping error/spill or continuously work to complete the corrective work.

The Department will apply all Liquidated Damages accumulatively.

RE-TESTING OF FAILURES

The Department's costs associated with re-testing of striping failures for Kentucky Method 203 shall be reimbursed to the Department by the Contractor. The reimbursement shall include mobilization of the Department's mobile striping vendor's mobile testing machine as well as the current per mile rate for the mobile striping according to the Cabinet's Master Agreement.

MEASUREMENT AND PAYMENT

STRIPING: The Department will measure the paint striping of each type in linear miles of paint stripe. The Department will measure the quantity at twice the rate for a 4-inch line when an 8-inch line is applied or twice the rate for a 6-inch line when a 12-inch line is applied.

The Department will pay 50% of the Contract Unit Bid price for the applicable bid items after application of all striping to a particular section of roadway. Contrary to Section 104.02.02, the overrun and underrun formula shall not apply to this Contract. The remaining payment will be made based upon the following procedure and the Payment Schedule:

1. Each section of striping will be evaluated in accordance with KM-202 or KM-203, as applicable, and the QC/QA testing specified herein, for the purpose of evaluating retroreflectivity.
2. If a Section is accepted in accordance with the appropriate Kentucky Methods, the Department will make final payment according to the Payment Schedule listed below.
3. If a section is not accepted in accordance with the appropriate Kentucky Methods, restripe the entire section within fifteen (15) calendar days after notification by the Engineer subject to the same requirements as the original striping at no additional cost to the Department. If the restriped Section is accepted in accordance with the appropriate Kentucky Methods, the Department will make final payment according to the following Payment Schedule. If the section is not restriped by October 15, 2019, the Department will not make final payment and re-striping may be required in the spring of 2020 where the corrective work will become a priority route and re-striping must be completed by June 1, 2020. If the Engineer does not require re-striping to be completed in the spring of 2020, the Contractor shall accept the deduction in payment for the section that has been determined to be unacceptable.

Waterborne & Durable Waterborne Paint Striping
Page 13 of 13

Payment Schedule

	Initial Payment	Final Payment	Total Payment
Section is Accepted	50%	50%	100%
Section is Not Accepted	50%	0%	50%

QUALITY CONTROL: The Department will measure and pay the quantity as one lump sum. The Department will not measure the QCP, the DLS, any actions and personnel required to carry out the QCP, any testing, any testing equipment, or any other work necessary to perform the specified QC/QA procedures for payment, but will consider them incidental to this item of work.

MAINTAIN AND CONTROL TRAFFIC: See Traffic Control Plan.

LAW ENFORCEMENT OFFICER: See Traffic Control Plan.

WATER BLASTING EXISTING STRIPE: See Special Note for Water Blasting Existing Stripe.

SPECIAL NOTE FOR CENTERLINE & EDGELINE RUMBLE STRIPES

Be advised there may be some centerline and edgeline rumble stripes to be retraced. Place centerline rumble stripes according to Standard Drawings TPM-155-02 and TPM-160-02. Place edgeline rumble stripes according to the detail drawings for centerline and edgeline rumble strips. Notify the Engineer if questions arise regarding the striping patterns. If necessary, the Engineer will obtain guidance from the District Traffic Engineer and/or the Division of Traffic.

SPECIAL NOTE FOR WATER BLASTING EXISTING STRIPE

This Special Note will apply where indicated on the plans or in the proposal. Section references herein are to the Department's 2012 Standard Specifications for Road and Bridge Construction.

1.0 DESCRIPTION. Remove pavement striping, temporary or permanent, from asphalt or concrete pavement using ultra-high pressure water.

2.0 MATERIALS AND EQUIPMENT.

2.1 Truck Mounted Ultra-high Pressure Pump and Water Tank. Use a truck having a separate hydrostatic transmission capable of speed increments of ± 1 foot per minute at operator's discretion. Use a pump capable of delivering a minimum of 30,000 psi to a bumper mounted deck containing an operator controlled rotating manifold that is speed variable up to at least 3,000 rpm and accepts interchangeable waterjet nozzles. Provide all necessary waterjet nozzle setups and patterns to ensure clean sufficient removal. Ensure the deck's discharge directs the water and removal material in a manner that is not hazardous to vehicles or pedestrians.

2.2 Water. Conform to Section 803.

3.0 CONSTRUCTION. Before starting work, provide the Engineer with a contractor work history of 2 projects where striping removal was completed acceptably for a similar type of pavement. If no history is available, complete 1,000 linear feet of striping removal and obtain the Engineer's approval before continuing.

Conduct striping removal under lane closures meeting the conditions of the MUTCD and Kentucky Standard Drawings and Specifications. Waterblast to remove temporary or permanent striping completely as the Engineer directs. Do not damage the pavement in any way and protect all joint seals. If damage is observed, stop the removal process until the operator can make changes and demonstrate acceptable striping removal. Repair any damage to the pavement. Vacuum all marking material and removal debris concurrently with the blasting operation.

4.0 MEASUREMENT. The Department will measure the quantity in linear feet. When the removal area's width exceeds 8 inches and a second pass is required, the Department will measure the length of the additional pass for Payment. The Department will not measure for payment additional passes for widths of 8 inches or less or passes to further eradicate markings. The Department will not measure repair of damaged pavement for payment and will consider it incidental to this item of work.

5.0 PAYMENT. The Department will make payment for the completed and accepted quantities under the following:

<u>Code</u>	<u>Pay Item</u>	<u>Pay Unit</u>
22664EN	Water Blasting Existing Stripe	Linear Foot

The Department will consider payment as full compensation for all work required under this note.

October 30, 2012

SPECIAL NOTE FOR PROJECTS TO BE RESURFACED IN 2019

Be advised that some projects listed herein may be scheduled for resurfacing in 2019. The Engineer may delete the striping on these routes from this Contract.

COORDINATION OF WORK WITH OTHERS

Be advised, the Department may issue permits for work on the Department's right of way adjacent to or within the limits of this project. See Sections 107.06 and 107.14. The Engineer will coordinate the work of the Contractor and the permit holders.

Be advised, there may be an active project(s) adjacent to or within this project. The Engineer will coordinate the work of the Contractors. See Section 105.06.

Be advised the Department may be performing work adjacent to or within this project. The Engineer will coordinate the Department's operations with the Contractor's work. See Section 105.11.

The Department will not grant any time extension or monetary consideration, and will not consider any claims if the Contractor's forces are delayed in their operations.

TRAFFIC CONTROL PLAN DURABLE WATERBORNE AND WATERBORNE PAINT STRIPING

1. Maintain and Control Traffic in accordance with the Standard Specifications for Road and Bridge Construction, Supplemental Specification, Standard and Sepia Drawings, and the MUTCD, current editions.
2. Contrary to Section 112, include all items necessary to maintain and control traffic in the lump sum bid item “Maintain and Control Traffic”. The Department will measure and pay only the bid items listed; consider all other work and necessary items to be incidental to the listed bid items. The Department will measure and pay “Maintain and Control Traffic” as one lump sum.
3. Maintain possession of all temporary traffic control items, devices, materials, and incidentals, unless otherwise specified in the proposal, when no longer needed.
4. If the Contractor desires to deviate from the traffic control scheme outlined in the Standard Drawings, prepare an alternate plan and present it in writing to the Engineer. Do not use the alternate plan until reviewed and approved by the District Engineer and the Divisions of Construction, Maintenance, and Traffic Operations.
5. Provide for the Contractor’s vehicles to always move with and not across or against the flow of traffic. Do not allow vehicles to make U-turns at any location. Do not allow the striper to stop and back down the road or ramps to stripe gore lines and turn lanes. Require vehicles to enter or leave work areas in a manner that will not be hazardous to, or interfere with, normal traffic flow. Do not allow vehicles to park or stop within the right-of-way except within work areas designated by the Engineer. Do not allow personal vehicles to park within the right-of-way except in specific areas designated by the Engineer.
6. Do not allow the paint supply truck to operate as one of the traffic control vehicles shown on the Standard Drawings. If one of the required traffic control vehicles experiences mechanical problems or for some other reason is not available to remain in position as shown in the traffic control scheme, cease the striping operation until all required vehicles are in place.
7. Do not perform striping operations on any roadway during the peak times of the day, holiday periods, or special events as determined by the Engineer.
8. On two-lane, two-way highways, make provisions to the satisfaction of the Engineer to periodically allow traffic to safely pass the train of vehicles in the striping operation.

Traffic Control Plan
Durable Waterborne & Waterborne Paint Striping
Page 2 of 2

9. In low speed, urban situations, the Engineer may permit the Contractor to delete the intermediate trail vehicle between the striper and the final trail vehicle shown on the Standard Drawings.

10. If requested by the Contractor, the Engineer may approve Law Enforcement Officer Police Support on Interstate highways when striping operations are taking place. If the Contractor requests Law Enforcement Officer Police Support on other than Interstate Highways, provide written justification for the Engineer's approval. If approved, provide two (2) police support units for each lane closure, each unit consisting of an off-duty law enforcement officer from any police agency having lawful jurisdiction and a police car equipped with externally mounted flashing blue lights. Place the police support unit at locations determined by the Engineer. The Department will measure and pay for each approved individual police support unit on a per hour basis for the officer with the police vehicle.

PART II
SPECIFICATIONS AND STANDARD DRAWINGS

SPECIFICATIONS REFERENCE

Any reference in the plans or proposal to previous editions of the *Standard Specifications for Road and Bridge Construction* and *Standard Drawings* are superseded by *Standard Specifications for Road and Bridge Construction, Edition of 2012* and *Standard Drawings, Edition of 2016*.

SUPPLEMENTAL SPECIFICATIONS

The contractor shall use the Supplemental Specifications that are effective at the time of letting.
The Supplemental Specifications can be found at the following link:

<http://transportation.ky.gov/Construction/Pages/Kentucky-Standard-Specifications.aspx>

2016 STANDARD DRAWINGS THAT APPLY

APPROACHES, ENTRANCES, AND MAIL BOX TURNOUT	RPM-110-07
PAVEMENT MARKER ARRANGEMENTS MULTI-LANE ROADWAYS.....	TPM-100-03
PAVEMENT MARKER ARRANGEMENTS MULTI-LANE ROADWAYS.....	TPM-105-03
PAVEMENT MARKER ARRANGEMENTS MULTI-LANE ROADWAYS.....	TPM-110-03
PAVEMENT MARKER ARRANGEMENTS TWO-LANE TWO-WAY ROADWAYS	TPM-115-03
PAVEMENT MARKER ARRANGEMENT TWO-LANE TO FOUR-LANE TRANSITIONS.....	TPM-120-03
PAVEMENT MARKER ARRANGEMENT EXIT-GORE AND OFF-RAMP.....	TPM-125-03
PAVEMENT MARKER ARRANGEMENT FOR PARALLEL DECELERATION LANE.....	TPM-126
PAVEMENT MARKER ARRANGEMENT ON-RAMP WITH TAPERED ACCELERATION LANE.....	TPM-130-03
PAVEMENT MARKER ARRANGEMENT ON-RAMP WITH PARALLEL ACCELERATION LANE.....	TPM-135-03
PAVEMENT MARKER ARRANGEMENTS TWO-WAY LEFT TURN LANE	TPM-140-03
PAVEMENT MARKER ARRANGEMENT CHANNELIZED INTERSECTION	TPM-145-03
CENTERLINE RUMBLE STRIPS.....	TPM-150-03
CENTERLINE RUMBLE STRIP 4 INCH STRIPING	TPM-155-02
CENTERLINE RUMBLE STRIP 6 INCH STRIPING	TPM-160-02
MOBILE OPERATION FOR PAINT STRIPING CASE I	TTS-100-02
MOBILE OPERATION FOR PAINT STRIPING CASE II	TTS-105-02
MOBILE OPERATION FOR PAINT STRIPING CASE III.....	TTS-110-02
MOBILE OPERATION FOR PAINT STRIPING CASE IV.....	TTS-115-02
MOBILE OPERATION FOR DURABLE STRIPING CASE I.....	TTS-120-02
MOBILE OPERATION FOR DURABLE STRIPING CASE II	TTS-125-02
MOBILE OPERATION FOR DURABLE STRIPING CASE III.....	TTS-130-02
MOBILE OPERATION FOR DURABLE STRIPING CASE IV.....	TTS-135-02

COUNTY OF	SHEET NO.
TERMIN.	

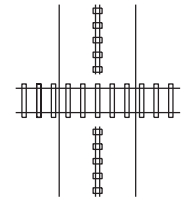
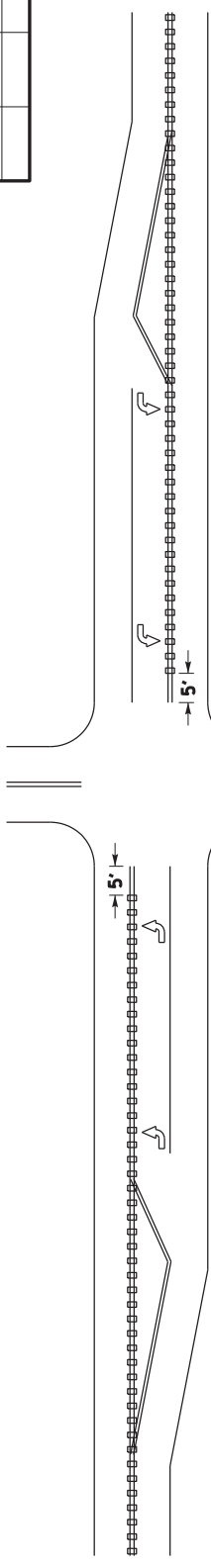

HIGHWAY-RAIL GRADE CROSSINGS ③

INTERSECTIONS WITH LEFT-TURN LANES ①

INTERSECTIONS WITHOUT LEFT-TURN LANES ①

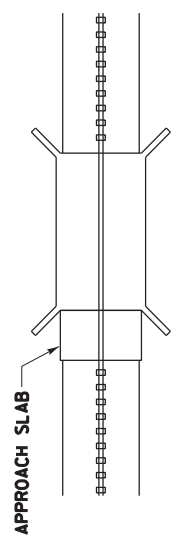

BRIDGE DECK/APPROACH SLAB ④

DRIVEWAYS/MINOR COMMERCIAL ENTRANCES ⑤

~ NOTES ~

- ① CENTERLINE RUMBLE STRIPS SHALL BE OMITTED THROUGH MAJOR INTERSECTIONS WITH, OR WITHOUT, LEFT-TURN LANES. OMIT THE CENTERLINE RUMBLE STRIPS APPROXIMATELY 5' IN ADVANCE OF THE AREA WHERE THE CENTERLINE PAVEMENT MARKINGS HAVE BEEN OMITTED (NORMALLY WHERE SIDE STREET RADIUS INTERSECTS MAINLINE).
- ② CENTERLINE RUMBLE STRIPS SHALL NOT BE INSTALLED THROUGH MARKED CROSSWALKS. OMIT THE CENTERLINE RUMBLE STRIPS APPROXIMATELY 5' IN ADVANCE OF MARKED CROSSWALKS.
- ③ CENTERLINE RUMBLE STRIPS SHALL NOT BE INSTALLED ACROSS HIGHWAY-RAIL GRADE CROSSINGS.
- ④ CENTERLINE RUMBLE STRIPS SHALL NOT BE INSTALLED ON BRIDGE DECKS OR APPROACH SLABS.
- ⑤ CENTERLINE RUMBLE STRIPS SHALL BE INSTALLED THROUGH DRIVEWAYS & MINOR COMMERCIAL ENTRANCES.
6. CENTERLINE RUMBLE STRIPS SHOULD BE OMITTED WHERE THE POSTED SPEED LIMIT IS 45 MPH OR LESS, OR WHERE LANE WIDTHS ARE LESS THAN 11 FT.

BID ITEM AND UNIT TO BID
CENTERLINE RUMBLE STRIPS

LF

DRAWING NOT TO SCALE
USE WITH CUR. STD. DWGS.
TPM-155 AND TPM-160

KENTUCKY
DEPARTMENT OF HIGHWAYS
CENTERLINE
RUMBLE STRIPS

SUBMITTED: *B. [Signature]*
II-23-16
DATE
002

COUNTY OF	TITLING	SHEET

PLAN VIEW

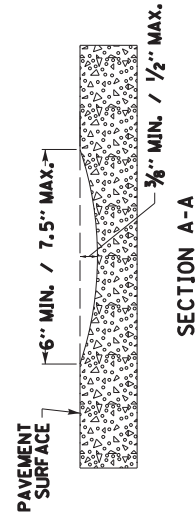
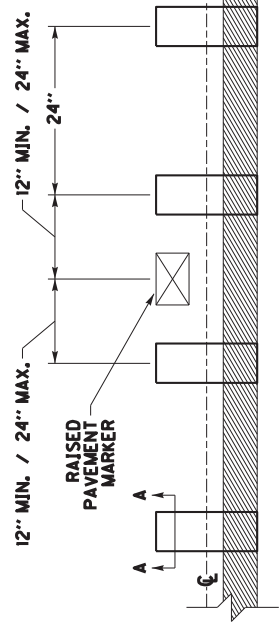
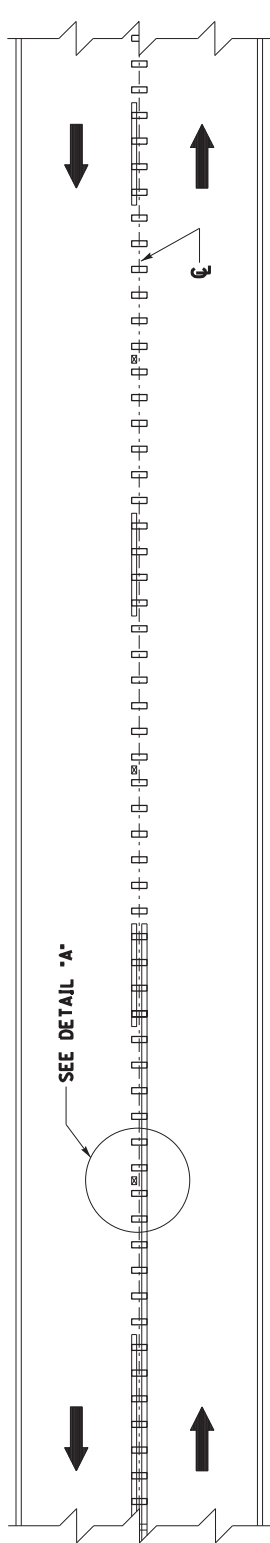

RUMBLE STRIP DETAIL

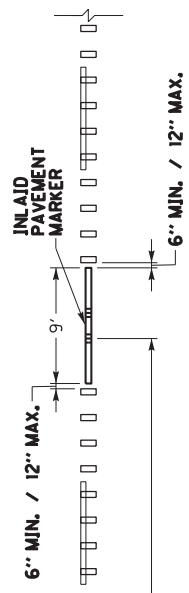
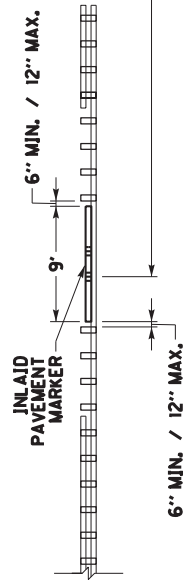

DETAIL FOR CENTERLINE RUMBLE STRIPS WITH INLAID PAVEMENT MARKERS

NOTES

1. DISTANCES SHOWN ARE APPROXIMATE. MAINTAIN RUMBLE STRIP DIMENSIONS AND SPACING AS MUCH AS POSSIBLE.
2. CENTERLINE RUMBLE STRIPS SHALL BE INSTALLED IN LINE WITH THE CENTER OF THE ROADWAY AS MUCH AS POSSIBLE.
3. DISCONTINUE CENTERLINE RUMBLE STRIPS AT LEAST 12" BEFORE AND AFTER THE CENTER OF EACH RAISED PAVEMENT MARKER, AND AT LEAST 6" BEFORE AND AFTER THE GROOVE FOR EACH INLAID PAVEMENT MARKER. INSTALL AS MANY RUMBLE STRIPS AS POSSIBLE BETWEEN ADJACENT PAVEMENT MARKERS WHILE MAINTAINING THE 24" CYCLE.
4. DO NOT INSTALL CENTERLINE RUMBLE STRIPS IN AREAS INDICATED ON TPM-150.
5. CENTERLINE RUMBLE STRIPS SHOULD BE OMITTED WHERE THE POSTED SPEED LIMIT IS 45 MPH OR LESS, OR WHERE LANE WIDTHS ARE LESS THAN 11 FT.

BID ITEM AND UNIT TO BID
CENTERLINE RUMBLE STRIPS

LF

DRAWING NOT TO SCALE
USE WITH CUR. STD. DWG.
TPM-150

KENTUCKY
DEPARTMENT OF HIGHWAYS

CENTERLINE
RUMBLE STRIPS
4 INCH STRIPING

SUBMITTED: *B. [Signature]*
11-23-16
DWG
003

COUNTY OF	SHEET NO.
TOWNSHIP	

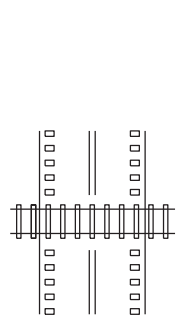
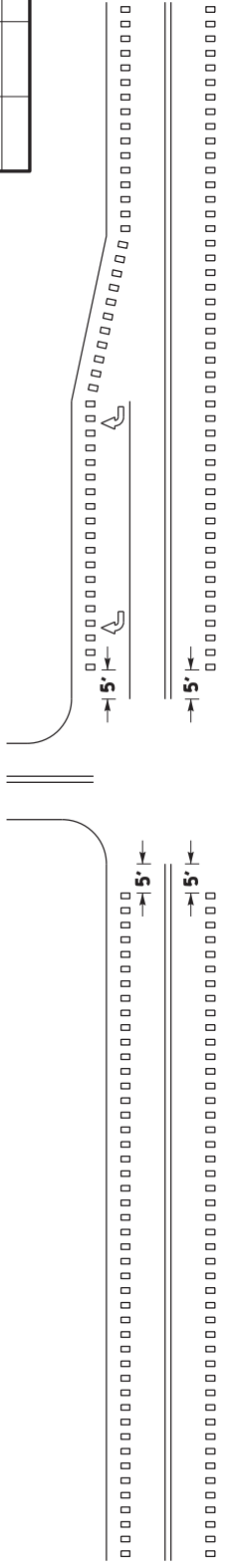

INTERSECTIONS WITH OR WITHOUT
RIGHT TURN LANES ①

MARKED CROSSWALK ②

HIGHWAY-RAIL GRADE CROSSINGS ③

APPROACH SLAB

BRIDGE DECK/APPROACH SLAB ④

DRIVEWAYS/MINOR
COMMERCIAL ENTRANCES ⑤

MAILBOX TURNOUTS ⑥

~ NOTES ~

- ① RUMBLE STRIPS SHALL BE OMITTED THROUGH MAJOR INTERSECTIONS WITH, OR WITHOUT, RIGHT-TURN LANES. OMIT RUMBLE STRIPS APPROXIMATELY 5' IN ADVANCE OF THE AREA WHERE EDGELINE PAVEMENT MARKINGS HAVE BEEN OMITTED (NORMALLY WHERE SIDE STREET RADIUS INTERSECTS MAINLINE).
- ② RUMBLE STRIPS SHALL NOT BE INSTALLED THROUGH MARKED CROSSWALKS. OMIT RUMBLE STRIPS APPROXIMATELY 5' IN ADVANCE OF MARKED CROSSWALKS.
- ③ RUMBLE STRIPS SHALL NOT BE INSTALLED ACROSS HIGHWAY-RAIL GRADE CROSSINGS.
- ④ RUMBLE STRIPS SHALL NOT BE INSTALLED ON BRIDGE DECKS OR APPROACH SLABS.
- ⑤ RUMBLE STRIPS SHALL BE INSTALLED THROUGH DRIVEWAYS & MINOR COMMERCIAL ENTRANCES.
- ⑥ RUMBLE STRIPS SHALL BE INSTALLED THROUGH MAILBOX TURNOUTS.
7. RUMBLE STRIPS SHOULD BE OMITTED WHERE THE POSTED SPEED LIMIT IS 45 MPH OR LESS.

DRAWING NOT TO SCALE

USE WITH SEPIA 006, 007,
AND 008

KENTUCKY
DEPARTMENT OF HIGHWAYS
SHOULDER & EDGELINE
RUMBLE STRIP DETAILS

BID ITEMS AND UNIT TO BID
EDGELINE RUMBLE STRIPS
SHOULDER RUMBLE STRIPS

LF
LF

SUBMITTED: *B. [Signature]*
DATE: 11-23-16

005

COUNTY OF	TITLING	SHEET
-----------	---------	-------

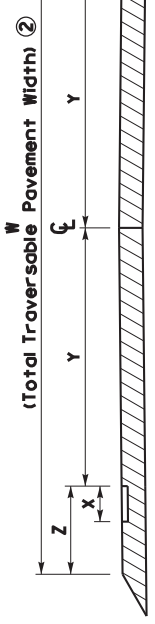

PAVEMENT CROSS-SECTION

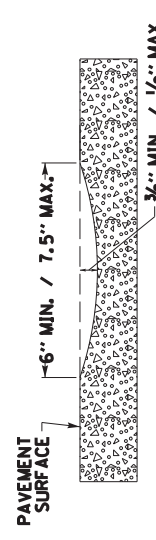
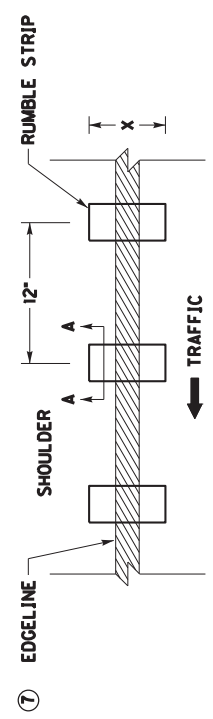

PAVEMENT WIDTH (W) ②	RUMBLE LENGTH (X) ⑥	ELRS ONLY		CLRS & ELRS	
		LANE WIDTH (Y) ③	SHOULDER WIDTH (Z) ④	LANE WIDTH (Y) ③	SHOULDER WIDTH (Z) ④
20'	8"	9'	1'	N/A	N/A
21'	8"	9.5'	1'	N/A	N/A
22'	8"	10'	1'	N/A	N/A
23'	8"	10'	1.5'	N/A	N/A
24'	8"	10.5'	1.5'	N/A	N/A
25'	8"	N/A	N/A	11'	1.5'
26'	8"	N/A	N/A	11'	2'
27'	8"	N/A	N/A	11.5'	2'
28'	8"	N/A	N/A	12'	2'
29'	8"	N/A	N/A	12'	2.5'
30'	8"	N/A	N/A	12'	3'
31'	8"	N/A	N/A	12'	3.5'
32'	8"	N/A	N/A	12'	4'
33'	8"	N/A	N/A	12'	4.5'

NOTES

1. EDGELINE RUMBLE STRIPS SHOULD BE INSTALLED ACCORDING TO THE DIMENSIONS PROPOSED ABOVE UNLESS THERE IS AN ENGINEERING BASIS THAT SUPPORTS A CHANGE IN DIMENSION. FOR EXAMPLE, IF THE EXISTING LANE WIDTH IS NARROWER THAN THE LANE WIDTH PROPOSED IN THIS DRAWING AND THE EXISTING SHOULDER PAVEMENT DEPTH IS NOT SUITABLE TO BE CONVERTED INTO A PORTION OF THE PROPOSED LANE WIDTH, THEN THE EXISTING LANE WIDTH SHOULD BE USED INSTEAD OF THE WIDTH PROPOSED IN THIS DRAWING.
2. PAVEMENT WIDTH (W) IS THE TOTAL WIDTH OF TRAVERSABLE PAVEMENT. DO NOT INCLUDE THE WIDTH OF ANY NON-TRAVERSABLE PAVEMENT, SUCH AS PAVEMENT WEDGES, WHEN MEASURING THE PAVEMENT WIDTH (W).
3. LANE WIDTH (Y) TO BE MEASURED FROM CENTER OF ROAD TO LANE SIDE EDGE OF RUMBLE STRIP.
4. PAVED SHOULDER WIDTH (Z) TO BE MEASURED FROM LANE SIDE EDGE OF RUMBLE STRIP TO OUTSIDE EDGE OF TRAVERSABLE PAVEMENT.
5. DISTANCES SHOWN ARE APPROXIMATE. MAINTAIN RUMBLE STRIP DIMENSIONS AND SPACING AS MUCH AS POSSIBLE. IF THE TYPICAL SECTION SHOWS A LANE WIDTH (Y) AND/OR SHOULDER WIDTH (Z) THAT DIFFERS FROM THE WIDTHS LISTED IN THIS DRAWING, THE ENGINEER SHALL DETERMINE THE LANE WIDTH (Y) AND/OR SHOULDER WIDTH (Z) AT THE TIME OF CONSTRUCTION.
NOTE: CENTERLINE RUMBLE STRIPS SHOULD BE OMITTED WHEN THE LANE WIDTH (Y) IS LESS THAN 11 FT.
6. RUMBLE LENGTH (X) MAY BE MODIFIED AS THE ENGINEER DIRECTS. IF THE SHOULDER WIDTH (Z) IS EQUAL TO OR LESS THAN THE PROPOSED RUMBLE LENGTH (X).
7. PLACE THE EDGELINE MARKING IN THE CENTER OF THE RUMBLE STRIP.
8. EDGELINE RUMBLE STRIPS SHOULD BE OMITTED WHERE THE POSTED SPEED LIMIT IS 45 MPH OR LESS.

BID ITEM AND UNIT TO BID
EDGELINE RUMBLE STRIPS

LF

DRAWING NOT TO SCALE

USE WITH SEPIA 005

KENTUCKY
DEPARTMENT OF HIGHWAYS
EDGELINE RUMBLE STRIP
DETAILS
TWO LANE ROADWAYS

SUBMITTED: *B. [Signature]*
DATE: 11-23-16
006

COUNTY OF	SHEET
TERMIN	007

PAVEMENT WIDTH (W) ②	RUMBLE LENGTH (X) ⑤	OFFSET ⑥	CLRS & SRS	
			LANE WIDTH (Y) ③	SHOULDER WIDTH (Z) ④
34'	8"	6"	12'	5'
35'	8"	6"	12'	5.5'
36'	8"	6"	12'	6'
37'	12"	12"	12'	6.5'
38'	12"	12"	12'	7'
39'	12"	12"	12'	7.5'
>=40'	16"	12"	12'	>=8'

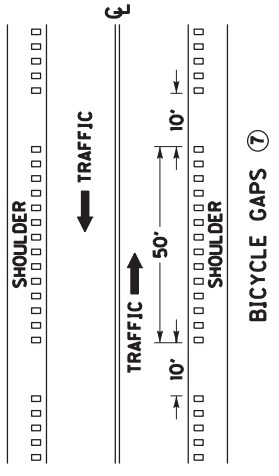
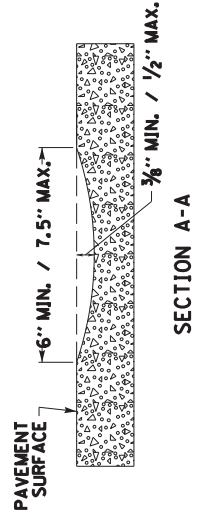
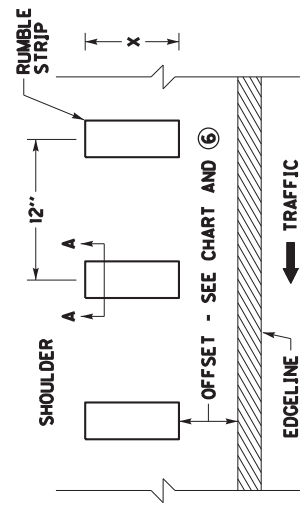
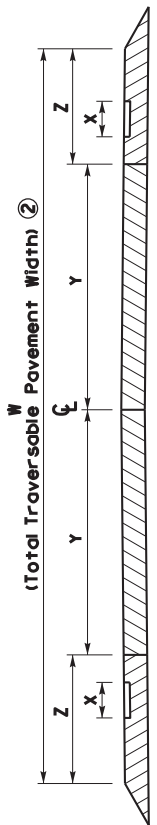

~ NOTES ~

- SHOULDER RUMBLE STRIPS SHOULD BE INSTALLED ACCORDING TO THE DIMENSIONS PROPOSED ABOVE UNLESS THERE IS AN ENGINEERING BASIS THAT SUPPORTS A CHANGE IN DIMENSION. FOR EXAMPLE, IF THE EXISTING LANE WIDTH IS NARROWER THAN THE LANE WIDTH PROPOSED IN THIS DRAWING AND THE EXISTING SHOULDER PAVEMENT DEPTH IS NOT SUITABLE TO BE CONVERTED INTO A PORTION OF THE PROPOSED LANE WIDTH, THEN THE EXISTING LANE WIDTH SHOULD BE USED INSTEAD OF THE WIDTH PROPOSED IN THIS DRAWING.
- PAVEMENT WIDTH (W) IS THE TOTAL WIDTH OF TRAVERSABLE PAVEMENT. DO NOT INCLUDE THE WIDTH OF ANY NON-TRAVERSABLE PAVEMENT, SUCH AS PAVEMENT WEDGES, WHEN MEASURING THE PAVEMENT WIDTH (W).
- LANE WIDTH (Y) TO BE MEASURED FROM CENTER OF ROAD TO CENTER OF EDGELINE STRIPE.
- PAVED SHOULDER WIDTH (Z) TO BE MEASURED FROM CENTER OF EDGELINE STRIPE TO OUTSIDE EDGE OF TRAVERSABLE PAVEMENT. DISTANCES SHOWN ARE APPROXIMATE. MAINTAIN RUMBLE STRIP DIMENSIONS AND SPACING AS MUCH AS POSSIBLE. IF THE TYPICAL SECTION SHOWS A LANE WIDTH (Y) AND/OR SHOULDER WIDTH (Z) THAT DIFFERS FROM THE WIDTHS LISTED IN THIS DRAWING, THE ENGINEER SHALL DETERMINE THE LANE WIDTH (Y) AND/OR SHOULDER WIDTH (Z) AT THE TIME OF CONSTRUCTION. NOTE: CENTERLINE RUMBLE STRIPS SHOULD BE OMITTED WHEN THE LANE WIDTH (Y) IS LESS THAN 11 FT.
- RUMBLE LENGTH (X) AND/OR OFFSET DISTANCE MAY BE MODIFIED AS THE ENGINEER DIRECTS, IF THE SHOULDER WIDTH (Z) IS EQUAL TO OR LESS THAN THE COMBINED WIDTH OF THE PROPOSED RUMBLE LENGTH (X) AND OFFSET DISTANCE.
- ALL SHOULDER RUMBLE STRIPS ALONG SHOULDERS THAT ARE 5' OR WIDER SHOULD INCLUDE BICYCLE GAPS AS DETAILED.
- SHOULDER RUMBLE STRIPS SHOULD BE OMITTED WHERE THE POSTED SPEED LIMIT IS 45 MPH OR LESS.

BID ITEM AND UNIT TO BID
SHOULDER RUMBLE STRIPS

LF

USE WITH SEPIA 005

KENTUCKY
DEPARTMENT OF HIGHWAYS

SHOULDER RUMBLE STRIP
DETAILS
TWO LANE ROADWAYS

SUBMITTED: *B. [Signature]* DATE: 11-23-16

007

DRAWING NOT TO SCALE

COUNTY OF	TITLING	SHEET
-----------	---------	-------

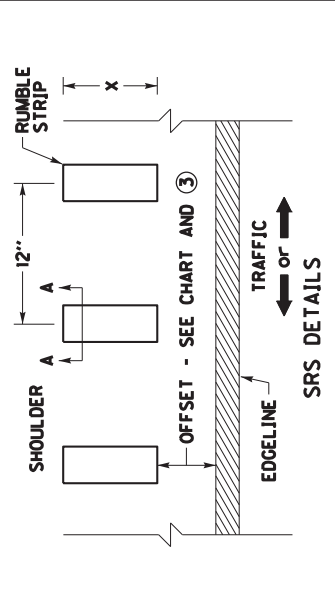
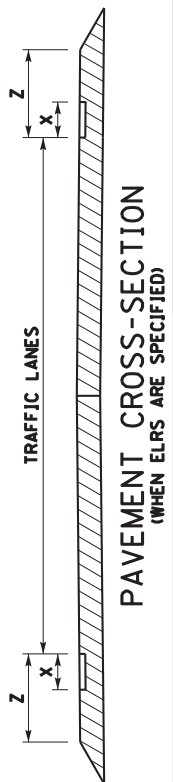
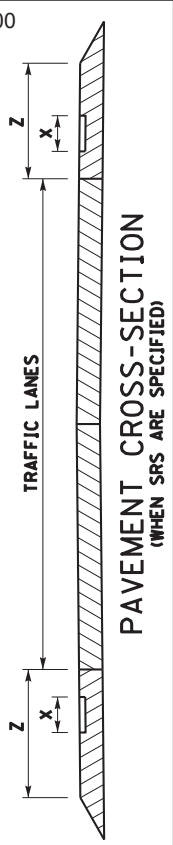

SHOULDER WIDTH (Z) ②	RUMBLE TYPE ①	RUMBLE LENGTH (X) ③	OFFSET ④
>1'	ELRS	8"	N/A
2'	ELRS OR SRS	8"	ELRS-N/A SRS-6"
3'	ELRS OR SRS	8"	ELRS-N/A SRS-6"
4'	ELRS OR SRS	8"	ELRS-N/A SRS-6"
5'	SRS ⑥	8"	6"
6'	SRS ⑥	8"	6"
7'	SRS ⑥	12"	12"
>8'	SRS ⑥	16"	12"

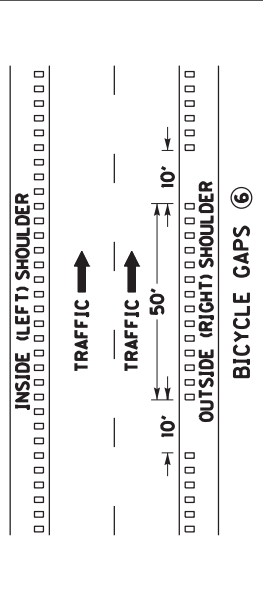
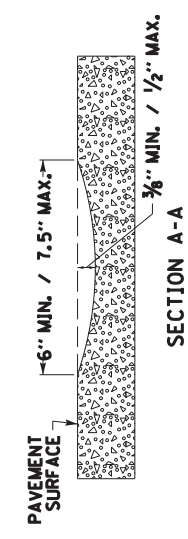
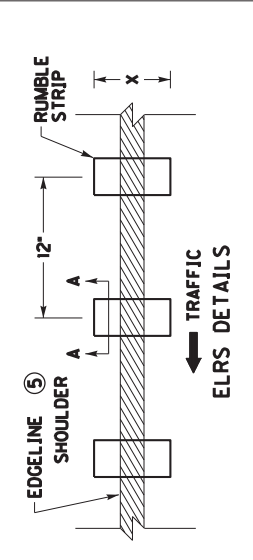

- ~ NOTES ~
- FOR MULTI-LANE ROADWAYS, THE RUMBLE TYPE TO BE INSTALLED IS BASED ON SHOULDER WIDTH (Z), FOR SHOULDER WIDTHS OF 2', 3', AND 4' THE RUMBLE TYPE MAY BE SPECIFIED AS EITHER EDGE LINE RUMBLE STRIPS (ELRS) OR SHOULDER RUMBLE STRIPS (SRS). IN THESE SITUATIONS, THE RUMBLE TYPE TO BE INSTALLED WILL BE SPECIFIED IN THE PLANS, PROPOSAL, AND/OR BID ITEMS, OR AS DIRECTED BY THE ENGINEER.
 - WHEN ELRS ARE SPECIFIED, SHOULDER WIDTH (Z) IS FROM LANE SIDE EDGE OF RUMBLE STRIP TO OUTSIDE EDGE OF TRAVERSABLE PAVEMENT. WHEN SRS ARE SPECIFIED, SHOULDER WIDTH (Z) IS FROM CENTER OF EDGE LINE STRIPE TO OUTSIDE EDGE OF TRAVERSABLE PAVEMENT.
 - RUMBLE LENGTH (X) AND/OR OFFSET DISTANCE MAY BE MODIFIED AS THE ENGINEER DIRECTS. IF THE SHOULDER WIDTH (Z) IS EQUAL TO OR LESS THAN THE COMBINED WIDTH OF THE PROPOSED RUMBLE LENGTH (X) AND OFFSET DISTANCE.
 - DISTANCES SHOWN ARE APPROXIMATE. MAINTAIN RUMBLE STRIP DIMENSIONS AND SPACING AS MUCH AS POSSIBLE.
 - WHEN ELRS ARE SPECIFIED, THE EDGE LINE MARKING SHALL BE PLACED IN THE CENTER OF THE RUMBLE STRIP.
 - SHOULDER RUMBLE STRIPS (SRS) ALONG OUTSIDE (RIGHT) SHOULDERS THAT ARE 5' OR WIDER SHOULD INCLUDE BICYCLE GAPS AS DETAILED. BICYCLE GAPS ARE NOT REQUIRED ON INSIDE (LEFT) SHOULDERS. BICYCLE GAPS SHALL NOT BE USED ON INTERSTATES AND PARKWAYS.
 - RUMBLE STRIPS SHOULD BE OMITTED WHERE THE POSTED SPEED LIMIT IS 45 MPH OR LESS, OR WHEN THE SHOULDER WIDTH IS LESS THAN 1 FT.

DRAWING NOT TO SCALE

USE WITH SEPIA 005

KENTUCKY
DEPARTMENT OF HIGHWAYS

RUMBLE STRIP DETAILS
MULTI-LANE ROADWAYS
AND RAMP

SUBMITTED: *B. [Signature]* JL-23-16 DATE

008

BID ITEMS AND UNIT TO BID
SHOULDER RUMBLE STRIPS
EDGE LINE RUMBLE STRIPS

LF
LF

PART III

EMPLOYMENT, WAGE AND RECORD REQUIREMENTS

**TRANSPORTATION CABINET
DEPARTMENT OF HIGHWAYS**

**LABOR AND WAGE REQUIREMENTS
APPLICABLE TO OTHER THAN FEDERAL-AID SYSTEM PROJECTS**

- I. Application
- II. Nondiscrimination of Employees (KRS 344)

I. APPLICATION

1. These contract provisions shall apply to all work performed on the contract by the contractor with his own organization and with the assistance of workmen under his immediate superintendence and to all work performed on the contract by piecework, station work or by subcontract. The contractor's organization shall be construed to include only workmen employed and paid directly by the contractor and equipment owned or rented by him, with or without operators.

2. The contractor shall insert in each of his subcontracts all of the stipulations contained in these Required Provisions and such other stipulations as may be required.

3. A breach of any of the stipulations contained in these Required Provisions may be grounds for termination of the contract.

3. If the contractor is in control of apprenticeship or other training or retraining, including on-the-job training programs, he shall not discriminate against an individual because of his race, color, religion, national origin, sex, disability or age forty (40) and over, in admission to, or employment in any program established to provide apprenticeship or other training.

4. The contractor will send to each labor union or representative of workers with which he has a collective bargaining agreement or other contract or understanding, a notice to be provided advising the said labor union or workers' representative of the contractor's commitments under this section, and shall post copies of the notice in conspicuous places available to employees and applicants for employment. The contractor will take such action with respect to any subcontract or purchase order as the administrating agency may direct as a means of enforcing such provisions, including sanctions for non-compliance.

Revised: January 25, 2017

II. NONDISCRIMINATION OF EMPLOYEES

**AN ACT OF THE KENTUCKY
GENERAL ASSEMBLY TO PREVENT
DISCRIMINATION IN EMPLOYMENT
KRS CHAPTER 344
EFFECTIVE JUNE 16, 1972**

The contract on this project, in accordance with KRS Chapter 344, provides that during the performance of this contract, the contractor agrees as follows:

1. The contractor shall not fail or refuse to hire, or shall not discharge any individual, or otherwise discriminate against an individual with respect to his compensation, terms, conditions, or privileges of employment, because of such individual's race, color, religion, national origin, sex, disability or age (forty and above); or limit, segregate, or classify his employees in any way which would deprive or tend to deprive an individual of employment opportunities or otherwise adversely affect his status as an employee, because of such individual's race, color, religion, national origin, sex, disability or age forty (40) and over. The contractor agrees to post in conspicuous places, available to employees and applicants for employment, notices to be provided setting forth the provisions of this nondiscrimination clause.

2. The contractor shall not print or publish or cause to be printed or published a notice or advertisement relating to employment by such an employer or membership in or any classification or referral for employment by the employment agency, indicating any preference, limitation, specification, or discrimination, based on race, color, religion, national origin, sex, or age forty (40) and over, or because the person is a qualified individual with a disability, except that such a notice or advertisement may indicate a preference, limitation, or specification based on religion, national origin, sex, or age forty (40) and over, or because the person is a qualified individual with a disability, when religion, national origin, sex, or age forty (40) and over, or because the person is a qualified individual with a disability, is a bona fide occupational qualification for employment.

EXECUTIVE BRANCH CODE OF ETHICS

In the 1992 regular legislative session, the General Assembly passed and Governor Brereton Jones signed Senate Bill 63 (codified as KRS 11A), the Executive Branch Code of Ethics, which states, in part:

KRS 11A.040 (7) provides:

No present or former public servant shall, within six (6) months following termination of his office or employment, accept employment, compensation, or other economic benefit from any person or business that contracts or does business with, or is regulated by, the state in matters in which he was directly involved during the last thirty-six (36) months of his tenure. This provision shall not prohibit an individual from returning to the same business, firm, occupation, or profession in which he was involved prior to taking office or beginning his term of employment, or for which he received, prior to his state employment, a professional degree or license, provided that, for a period of six (6) months, he personally refrains from working on any matter in which he was directly involved during the last thirty-six (36) months of his tenure in state government. This subsection shall not prohibit the performance of ministerial functions, including but not limited to filing tax returns, filing applications for permits or licenses, or filing incorporation papers, nor shall it prohibit the former officer or public servant from receiving public funds disbursed through entitlement programs.

KRS 11A.040 (9) states:

A former public servant shall not represent a person or business before a state agency in a matter in which the former public servant was directly involved during the last thirty-six (36) months of his tenure, for a period of one (1) year after the latter of:

- a) The date of leaving office or termination of employment; or
- b) The date the term of office expires to which the public servant was elected.

This law is intended to promote public confidence in the integrity of state government and to declare as public policy the idea that state employees should view their work as a public trust and not as a way to obtain private benefits.

If you have worked for the executive branch of state government within the past six months, you may be subject to the law's prohibitions. The law's applicability may be different if you hold elected office or are contemplating representation of another before a state agency.

Also, if you are affiliated with a firm which does business with the state and which employs former state executive-branch employees, you should be aware that the law may apply to them.

In case of doubt, the law permits you to request an advisory opinion from the Executive Branch Ethics Commission, 3 Fountain Place, Frankfort, Kentucky 40601; telephone (502) 564-7954.

Revised: January 27, 2017

Kentucky Equal Employment Opportunity Act of 1978

The requirements of the Kentucky Equal Employment Opportunity Act of 1978 (KRS 45.560-45.640) shall apply to this Contract. The apparent low Bidder will be required to submit EEO forms to the Division of Construction Procurement, which will then forward to the Finance and Administration Cabinet for review and approval. No award will become effective until all forms are submitted and EEO/CC has certified compliance. The required EEO forms are as follows:

- EEO-1: Employer Information Report
- Affidavit of Intent to Comply
- Employee Data Sheet
- Subcontractor Report

These forms are available on the Finance and Administration's web page under *Vendor Information, Standard Attachments and General Terms* at the following address:
<https://www.eProcurement.ky.gov>.

Bidders currently certified as being in compliance by the Finance and Administration Cabinet may submit a copy of their approval letter in lieu of the referenced EEO forms.

For questions or assistance please contact the Finance and Administration Cabinet by email at **finance.contractcompliance@ky.gov** or by phone at 502-564-2874.

EMPLOYEE RIGHTS UNDER THE FAIR LABOR STANDARDS ACT

THE UNITED STATES DEPARTMENT OF LABOR WAGE AND HOUR DIVISION

FEDERAL MINIMUM WAGE

\$7.25 PER HOUR

BEGINNING JULY 24, 2009

OVERTIME PAY At least 1½ times your regular rate of pay for all hours worked over 40 in a workweek.

CHILD LABOR An employee must be at least **16** years old to work in most non-farm jobs and at least **18** to work in non-farm jobs declared hazardous by the Secretary of Labor.

Youths **14** and **15** years old may work outside school hours in various non-manufacturing, non-mining, non-hazardous jobs under the following conditions:

No more than

- **3** hours on a school day or **18** hours in a school week;
- **8** hours on a non-school day or **40** hours in a non-school week.

Also, work may not begin before **7 a.m.** or end after **7 p.m.**, except from June 1 through Labor Day, when evening hours are extended to **9 p.m.** Different rules apply in agricultural employment.

TIP CREDIT Employers of “tipped employees” must pay a cash wage of at least \$2.13 per hour if they claim a tip credit against their minimum wage obligation. If an employee’s tips combined with the employer’s cash wage of at least \$2.13 per hour do not equal the minimum hourly wage, the employer must make up the difference. Certain other conditions must also be met.

ENFORCEMENT The Department of Labor may recover back wages either administratively or through court action, for the employees that have been underpaid in violation of the law. Violations may result in civil or criminal action.

Employers may be assessed civil money penalties of up to \$1,100 for each willful or repeated violation of the minimum wage or overtime pay provisions of the law and up to \$11,000 for each employee who is the subject of a violation of the Act’s child labor provisions. In addition, a civil money penalty of up to \$50,000 may be assessed for each child labor violation that causes the death or serious injury of any minor employee, and such assessments may be doubled, up to \$100,000, when the violations are determined to be willful or repeated. The law also prohibits discriminating against or discharging workers who file a complaint or participate in any proceeding under the Act.

ADDITIONAL INFORMATION

- Certain occupations and establishments are exempt from the minimum wage and/or overtime pay provisions.
- Special provisions apply to workers in American Samoa and the Commonwealth of the Northern Mariana Islands.
- Some state laws provide greater employee protections; employers must comply with both.
- The law requires employers to display this poster where employees can readily see it.
- Employees under 20 years of age may be paid \$4.25 per hour during their first 90 consecutive calendar days of employment with an employer.
- Certain full-time students, student learners, apprentices, and workers with disabilities may be paid less than the minimum wage under special certificates issued by the Department of Labor.

For additional information:



1-866-4-USWAGE

(1-866-487-9243)

TTY: 1-877-889-5627



WWW.WAGEHOUR.DOL.GOV

PART IV
INSURANCE

INSURANCE

The Contractor shall procure and maintain the following insurance in addition to the insurance required by law:

- 1) Commercial General Liability-Occurrence form – not less than \$2,000,000 General aggregate, \$2,000,000 Products & Completed Aggregate, \$1,000,000 Personal & Advertising, \$1,000,000 each occurrence.
- 2) Automobile Liability- \$1,000,000 per accident
- 3) Employers Liability:
 - a) \$100,000 Each Accident Bodily Injury
 - b) \$500,000 Policy limit Bodily Injury by Disease
 - c) \$100,000 Each Employee Bodily Injury by Disease
- 4) The insurance required above must be evidenced by a Certificate of Insurance and this Certificate of Insurance must contain one of the following statements:
 - a) "policy contains no deductible clauses."
 - b) "policy contains _____ (amount) deductible property damage clause but company will pay claim and collect the deductible from the insured."
- 5) KENTUCKY WORKMEN'S COMPENSATION INSURANCE. The contractor shall furnish evidence of coverage of all his employees or give evidence of self-insurance by submitting a copy of a certificate issued by the Workmen's Compensation Board.

The cost of insurance is incidental to all contract items. All subcontractors must meet the same minimum insurance requirements.

PART V
BID ITEMS

PROPOSAL BID ITEMS

192002

Page 1 of 1

Report Date 1/28/19

Section: 0001 - RS ROUTES CALDWELL COUNTY

LINE	BID CODE	ALT	DESCRIPTION	QUANTITY	UNIT	UNIT PRIC	FP	AMOUNT
0010	06520		PAVE STRIPING-WB PAINT-4 IN W MP ROUTES	1,026.54	MILE		\$	
0020	06520		PAVE STRIPING-WB PAINT-4 IN W RS ROUTES	34.78	MILE		\$	
0030	06521		PAVE STRIPING-WB PAINT-4 IN Y MP ROUTES	1,744.36	MILE		\$	
0040	06521		PAVE STRIPING-WB PAINT-4 IN Y RS ROUTES	1,835.75	MILE		\$	

Section: 0002 - OVERALL CONTRACT ITEMS

LINE	BID CODE	ALT	DESCRIPTION	QUANTITY	UNIT	UNIT PRIC	FP	AMOUNT
0050	02572		QUALITY CONTROL	1.00	LS		\$	
0060	02650		MAINTAIN & CONTROL TRAFFIC	1.00	LS		\$	
0070	20411ED		LAW ENFORCEMENT OFFICER	25.00	HOUR		\$	
0080	22664EN		WATER BLASTING EXISTING STRIPE	1,000.00	LF		\$	

Section: 0003 - DEMOBILIZATION

LINE	BID CODE	ALT	DESCRIPTION	QUANTITY	UNIT	UNIT PRIC	FP	AMOUNT
0090	02569		DEMOBILIZATION	1.00	LS		\$	

QUALIFICATIONS OF MONITORING SYSTEMS FOR PAVEMENT MARKINGS APPLICATION VEHICLES

1. SCOPE

- 1.1 This method covers the qualification requirements for monitoring systems of striping vehicles used to apply longitudinal lane markings to roadway surfaces (striping trucks) to assure adequate measures are used to monitor and record application properties of installed lane markings.
- 1.2 This method will be used for qualification of monitoring systems for each striping vehicle used to apply waterborne striping paint on KYTC District Wide Striping contracts.
- 1.3 This method does not purport to address all of the safety concerns, or any associated with its use. It is the responsibility of the user of this method to establish appropriate safety and health practices and determine the applicability of regulatory limitations prior to use.

2. BASIC REQUIREMENTS

- 2.1 Striping vehicle calibrated and maintained in operational condition.
- 2.2 Waterborne or durable waterborne striping paint with manufacturers certification of compliance to Section 842 or Section 846, as appropriate, of the [Kentucky Standard Specifications](#).
- 2.3 Beads of the gradation and coating(s) preference of the contractor intended to be utilized to meet the minimum retroreflectivity requirements of the contract.
- 2.4 Provide adequate location to verify distance monitoring devices.
- 2.5 Label each material container and monitoring system with a unique identification.

3. QUALIFICATION PROCEDURES

- 3.1 General
 - 3.1.1 Qualification and certification of calibration must be obtained annually, after January 1 of the contract year and prior to use of the striping vehicle for application of lane markings.
 - 3.1.2 Certification procedures shall be conducted by a licensed independent commercial scale calibration company.
 - 3.1.3 Qualification procedures and verifications shall be conducted by the Department.

3.1.4 Documentation of all measurements made for certification and qualification processes shall be reported on forms approved by the Department.

3.2 Weight monitoring system.

3.2.1 Obtain certification of weight monitoring systems prior to qualification of the monitoring system for a striping vehicle.

3.2.2 Obtain certification of calibration for each weight monitoring system installed on the striping vehicle.

3.2.2.1 Obtain certification of calibration from an independent commercial scale calibration company licensed through the Kentucky Department of Agriculture, [Division of Regulation and Inspection](#).

3.2.2.2 Determine the maximum working load of the system and divide into 10 uniform test intervals. Perform calibration of the system using certified Class F test weights conforming to NIST Handbook 105 at each identified interval.

3.2.2.3 Appropriate materials (paint or beads) may be utilized to apply build up loads equal to the displayed weight of the previous interval.

3.2.2.4 Indicated weight displayed by the data logger must be within 3% of the actual load.

3.2.2.5 Difference between indicated weights displayed by the data logger for consecutive intervals must be within 3% of the actual interval test load.

Example:

Tank capacity: 15,000 lbs.

Interval test load: 1,500 lbs.

Interval	Cert. Weight (CW)	Previous Displayed Load (Build-Up)	Actual Test Load (ATL)	Displayed Weight (DW)	Load Deviation (LD) = (ATL-DW)	% Load Deviation = ((ABS)LD/ATL) *100	Interval Deviation (ID) =CW-(DW-Previous DW)	% Interval Deviation = ((ABS)ID/CW)*100
0	0	0	0	0	0	0	-	-
1	1500	0	1500	1475	25	1.7	25	1.7
2	1500	1475	3000	2970	30	1.0	5	0.3
3	1500	2970	4500	4482	18	0.4	-12	0.8
...

BS = Absolute Value

3.3 Volume monitoring system (Stroke counter)

3.3.1 Obtain a sample of the paint to be used for qualification testing.

3.1.1 Determine the density of the sample in accordance with ASTM D1475.

- 3.3.2 Load the system with a suitable quantity of paint.
 - 3.3.2.1 Adjust the system to operating conditions and dispense a sufficient quantity of paint to ensure a continuous flow of material.
- 3.3.3 Zero the monitoring system.
- 3.3.4 Operate the system to dispense a minimum of 15 gallons of paint into an appropriately sized and tared container. Record the number of pump strokes made to dispense the material.
 - 3.3.4.1 Weigh the collected sample and determine the actual quantity of material dispensed in gallons.
 - 3.3.4.2 Calculate the scaling factor for system.
 - 3.3.4.3 Verify the number of pump strokes recorded by the monitoring system.
 - 3.3.4.4 Document the established scaling factor for the system and compare to the calculated scaling factor.
 - 3.3.4.5 Indicated volume displayed by the data logger must be within 3% of the actual volume dispensed.
- 3.4 Distance monitoring system (Electrical foot counter)
 - 3.4.1 Establish a straight-line distance using a suitable measuring device.
 - 3.4.2 Zero the monitoring system.
 - 3.4.3 Operate the striping vehicle for the established distance.
 - 3.4.3.1 Verify the distance recorded by the monitoring system.
 - 3.4.3.2 Indicated distance displayed by the data logger must be within 0.3% of the actual distance traveled.
- 3.5 Temperature monitoring system (Ambient, Surface, and Material)
 - 3.5.1 Obtain an appropriate temperature measurement using an NIST Traceable temperature measuring device.
 - 3.5.2 Obtain appropriate temperature measurement using the installed temperature measuring device.
 - 3.5.2.1 Verify the temperature measurement recorded by the monitoring system.

3.5.2.2 Indicated temperature displayed by the data logger must be within 2° F of the actual temperature.

3.6 Other monitoring systems

3.6.1 Monitoring systems not described herein shall be inspected for qualification upon notification to the Department.

4. FIELD VERIFICATION

4.1 The Department reserves the right to perform field verifications of qualified monitoring systems.

4.2 The Department reserves the right to perform field verifications to determine compliance to all stated application properties within the contract.

5. DISQUALIFICATION

5.1 Striping vehicles found to be out of tolerance (monitoring system for weight, volume, distance, or temperature) shall be disqualified.

5.2 Removal or replacement of any component of a monitoring system shall result in disqualification of the striping vehicle.

5.3 Disqualified striping vehicles will not be permitted to return to service until approved by the Department.

6. RECORD KEEPING

6.1 Quality control and verification checks performed by the contractor during production shall be documented and maintained. If requested, these records shall be provided to the Department.

APPROVED William Broyles
DIRECTOR
DIVISION OF MATERIALS

DATE 01/15/10

Kentucky Method 64-267-10
Dated 01/15/10

MATERIALS HANDLING





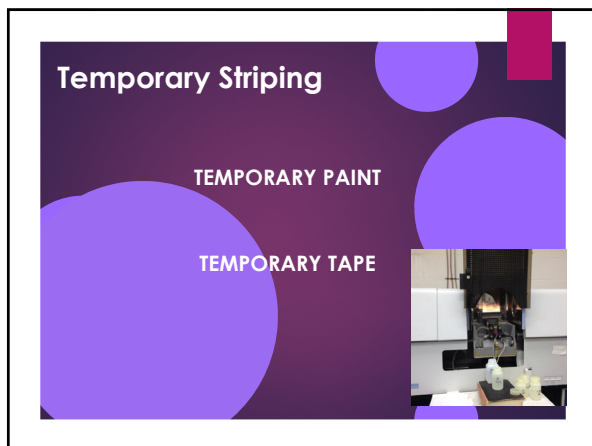

Temporary Paint Materials Requirement

- LESS THAN 120 DAYS – NO SAMPLE
- GREATER THAN 120 DAYS – SEND SAMPLES
 - Conform to Section 842 and 846
 - Manufacturer's Certification
 - Do not sample glass beads



Sarah Ramsay, Chemist (Traffic Paint)

Temporary Tape Materials Requirement

CONFORM TO SECTION 831: CONSTRUCTION ZONE TEMPORARY MARKING TAPES

MANUFACTURER'S CERTIFICATION

LIST OF APPROVED MATERIALS

Resurfacing, Rehabilitation and Restoration Contracts

WATERBORNE AND DURABLE WATERBORNE TRAFFIC PAINT

EXTRUDED THERMOPLASTIC

TYPE I TAPE

DO NOT SAMPLE GLASS BEADS!





Waterborne & Durable Waterborne Paint (Resurfacing, Rehabilitation & Restoration Contracts)

CONFORM TO SECTION 842 & 846

MANUFACTURER'S CERTIFICATION

RANDOMLY SAMPLE PAINT FROM STRIPER
Minimum of one per color per project
Paint samples should be taken from the striper

SITE MANAGER SAMPLE RECORD FORM



Extruded Thermoplastic
(Resurfacing, Rehabilitation & Restoration Contracts)

THERMOPLASTIC MUST MEET THE REQUIREMENTS OF SECTION 837

MANUFACTURER'S CERTIFICATION

SITE MANAGER SAMPLE RECORD FORM

UNOPENED BAG CLEARLY LABELED WITH THE BATCH NUMBER



Habiba Dowla, Instrumental Analysis,
Senior Chemist

Sampling Extruded Thermoplastic
(Resurfacing, Rehabilitation & Restoration Contracts)

SMALL QUANTITIES < 250 POUNDS
Manufacturer's Certification

QUANTITIES > 250 POUNDS
Manufacturer's Certification

Provide one unopened bag of thermoplastic per batch per color of material delivered to the contract
Batch number clearly labeled.

Type I Tape
 (Resurfacing, Rehabilitation & Restoration Contracts)

MEET THE REQUIREMENTS OF SECTION 836 OF THE STANDARD SPECIFICATIONS

Manufacturer's Certification

Minimum retroreflectivity requirements
 White: 500 mcd/m²/lux
 Yellow: 500 mcd/m²/lux

Waterborne & Durable Waterborne Paint
 (District Wide Striping Contracts)

CONFORM TO SECTION 842 & 846
 Deduction shall apply to color from 4.1 to 6.0 (also for Resurf.)
 No paint accepted with color deviation > 6.0 (also for Resurf.)
 Minimum contrast ratio for white 0.990 and yellow is 0.980

MANUFACTURER'S CERTIFICATION

SAMPLES
 Minimum of one per color per truck per week
 Paint samples should be taken from the striper

SITE MANAGER SAMPLE RECORD FORM

Ed Ferrane, Wet Chemist

File Edit Services Window Help

Maintain Sample Information

Basic Sample Data Addl Sample Data Contract Other Tests

Smpl ID: 013408LS120051 Status: Received

Revised By: Revising: Sample Date: 11/09/12

Link To: Link From: Log Date: 11/09/12

Smpl Type: PROJECT ACCEPTANCE Acpt Meth: TEST RESULTS

Material: 3310 TRAFFIC PAINT - WHITE

Sampler: bsummerv Summerville, Barry L.

P/S: CHP331100

Type: TRAFFIC MARKINGS City: BALTIMORE

Prod Num: CHP331100

Mfct: CHP331100

Town: Geog Area: DISTRICT 01

Intd Use:

Repr Qty: .000 GALLONS Lab Control Number: C013408LS120051

Auth By: Auth Date: 00/00/00 Lab Reference Number:

Lock Type: Locked By: bsummerv Lock Date: 11/9/2012 10:08:48

Contract: District: 01 Section: 340

File Edit Services Window Help

Maintain Sample Information

Basic Sample Data **Add Sample Data** Contract Other Tests

Smpl ID: 013408LS120051 Buy American:

Chemistry Lot Num: _____ Witnessed By: _____

Smpl Size: _____

Dist from Grade: _____

Station: _____ Offset: _____ Reference: _____

Smpld From: _____

Smpl Origin: _____

Control Type: BATCH NUMBER Cntrl Number: MPI9325W Seal Number: _____

Design Type: _____ Mix ID: _____

Plant ID: _____ Plant Type: _____

Creator User ID: brummerv Include Standard Remarks: Sample Created from DWR: DWR Date: 00/00/00

Last Modified User ID: bratchel Last Modified Date: 11/19/12 DWR Inspector: _____

* KYTC Cust 04/25/07

File Edit Services Window Help

Maintain Sample Information

Basic Sample Data **Add Sample Data** Contract Other Tests

Sample 013408LS120051

Contract ID	Project	Line Item	Item Code	Fed State Prj Nbr	Cont Est Matl Qty	Represented Qty	Material Unit	Reported Matl Qty	Satisfy Rep Matl Qty	Line Matl Qty
121006	DE04212411206	0220	06514	FD51 042 1241	1,200,000	000	GALLONS	2,051,000	0.000	PAVE

File Edit Services Window Help

Maintain Sample Information

Basic Sample Data **Add Sample Data** Contract **Other** Tests

Sample 013408LS120051

Type	ID	Description
Destination Lab	DL00640	Central Office Materials

File Edit Services Window Help

Maintain Sample Information

Basic Sample Data Add Sample Data Contract Other Tests

Sample: 013406LS120061

Test Method	Sample Test Nbr	Test Description
CHTRAFFCPT	1	TRAFFIC PAINT

Test Method: CHTRAFFCPT TRAFFIC PAINT

Lab ID: LU00643 CO Materials - Chemistry Section

Sample Test Nbr: 1 Received Date: 11/19/12

Charge Amount: \$430.00 Actual Start Date: 00/00/00

Actual Completion Date: 00/00/00

* KYTC Cust 04/16/07

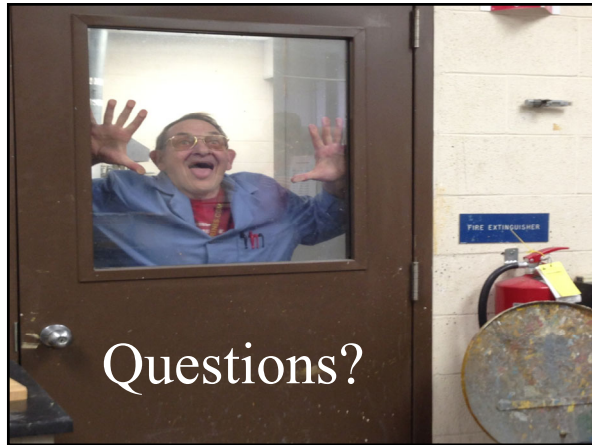

SECTION 831 — CONSTRUCTION ZONE TEMPORARY MARKING TAPES

831.01 DESCRIPTION. This section covers pavement marking material designed to provide reflective delineation in construction zones. This section covers the following types of marking material:

- A) **Type A.** Non-removable Pavement Marking Tape.
- B) **Type B.** Removable Pavement Marking Tape.

831.02 GENERAL.

831.02.01 Manufacture. Use a material consisting of a weather and traffic-resistant reflective film on a backing precoated with a pressure-sensitive adhesive.

831.02.02 Adhesive. Use a precoated pressure-sensitive adhesive that does not require a liner or activation.

831.02.03 Application Properties. Ensure that the material adheres to asphalt and concrete surfaces, when applied according to the manufacturer's recommendations, at or above surface temperatures of 40 °F. Ensure that the material does not require any protective devices such as traffic cones or barricades after application. Do not allow re-use of previously installed material.

831.02.04 Conformability and Thickness. Use material that is thin, flexible, formable, and remains conformed to the texture of the pavement surface following application. Ensure that the thickness of the material furnished is within 2 mils of the thickness of the material submitted for approval. Use tape with a minimum width of 4 inches.

831.02.05 Miscellaneous Requirements. Ensure that the supplied material is of good appearance, free from cracks, with edges true, straight, and unbroken. Make the material available in rolls with no more than 3 splices per 50 yards of length. Package the material according to accepted commercial standards. Ensure that the supplied material is capable of being stored at temperatures up to 100 °F for a period of one year after purchase without adversely affecting the physical properties stated in this section.

831.03 APPROVAL. The Department will approve temporary marking tapes based on conformance to KM 64-207 and the requirements of this section. The Department may remove temporary marking tapes from the Department's List of Approved Materials for poor field performance in Kentucky.

831.04 CERTIFICATION. Submit manufacturer's certification stating conformance to the requirements of this section for each shipment of approved temporary marking tapes delivered for use on projects. Clearly state the manufacturer, product name, product code and color as listed in the Department's List of Approved Materials. Identify the lot number(s), expiration date and quantity delivered.

831.05 ACCEPTANCE. The Department will accept temporary marking tapes based on verification of inclusion on the Department's List of Approved Materials, compliance of the manufacturer's certification, verification the expiration date will not be exceeded, and visual inspection of the temporary marking tape installation. The Department reserves the right to sample and test temporary marking tape, at the discretion of the Engineer, in

accordance with the Department's Field Sampling and Testing Manual.

SECTION 836 — DURABLE PREFORMED PAVEMENT MARKINGS TYPE I TAPE

836.01 GENERAL. Use preformed pavement marking material consisting of white or yellow films with retroreflective optics incorporated to provide immediate and continuing retroreflection.

Use preformed pavement marking material capable of adhering to new dense and open graded asphalt surfaces, during the paving operation, or portland cement concrete by a pre-coated pressure sensitive adhesive. The Engineer may require a primer to precondition the pavement surface. Ensure that the markings conform to pavement contours by the action of traffic. Ensure that, after application, the markings are immediately ready for traffic.

Ensure that these markings provide long term reflectivity, as determined in the following performance requirements, when applied according to the manufacturer's instructions.

Ensure that the preformed markings are suitable for use one year after the date of receipt when stored according to the manufacturer's recommendations.

836.02 REQUIREMENTS.

836.02.01 Composition. Use retroreflective preformed pavement markings consisting of a mixture of high quality polymeric materials, pigments, and retroreflective optics distributed throughout its base cross sectional area.

836.02.02 Reflectance. Ensure that the white and yellow markings have the following minimum reflectance values as measured according to the testing procedures of ASTM E 1701. Measure the coefficient of retroreflected luminance and express the value as millicandelas per square meter per lux [(mcd/m²)lx⁻¹].

MINIMUM REFLECTANCE			
Color	Entrance Angle	Observation Angle	Minimum Reflectance
White	88.76°	1.05°	500 minimum
Yellow	88.76°	1.05°	500 minimum

836.02.03 Skid Resistance. Ensure that the surface of the retroreflective material provides an initial minimum skid resistance value of 45 BPN when tested according to ASTM E 303.

836.02.04 Patchability. Ensure that the pavement marking material is capable of use for patching worn areas of the same type according to the manufacturer's recommendations.

836.02.05 Material Quality. Replace any material used as longitudinal or intersection markings that fails minimum reflectivity values or fails due to loss of adhesion or complete wear through. Minimum replacement zone is 300 feet of roadway

length or one intersection marking.

836.03 APPROVAL. The Department will approve Type I pavement marking tape based on conformance to KM 64-207 and this section.

836.04 CERTIFICATION. Submit manufacturer's certification stating conformance to the requirements of this section for each shipment of approved Type I pavement marking tape for use on projects. Clearly state the manufacturer, product name and product code and color as listed in the Department's List of Approved Materials. Identify the lot number(s), expiration date, and quantity delivered.

836.05 ACCEPTANCE. The Department will accept Type I pavement marking tape based on verification of inclusion on the Department's List of Approved Materials, compliance of the manufacturer's certification, and visual inspection of the installation of the Type I pavement marking tape.

SECTION 837 — EXTRUDED THERMOPLASTIC PAVEMENT MARKING MATERIALS

837.01 GENERAL. This section covers extruded thermoplastic pavement marking materials for permanent applications.

837.02 DROP ON BEADS. Use beads that will ensure the pavement marking material will meet retroreflectivity requirements. The Department will evaluate the beads as part of the marking system through retroreflectivity readings.

837.03 APPROVAL. Select materials that conform to the composition and physical characteristic requirements below when evaluated in accordance with AASHTO T-250 or other test methods as cited. The Department will sample and evaluate for approval each lot of thermoplastic material delivered for use per contract prior to installation of the thermoplastic material. Do not allow the installation of thermoplastic material until it has been approved by the Division of Materials. Allow the Department a minimum of 10 working days to evaluate and approve thermoplastic material from the date received by the Division of Materials.

837.03.01 Composition. Use a maleic-modified glycerol ester resin (alkyd binder) to formulate the thermoplastic material. Ensure the pigment, pre-mix beads, and filler are uniformly dispersed in the resin. Use material that is free from all dirt and foreign material. Provide independent analysis data and certification for each formulation stating the total concentration of each heavy metal present, the test method used for each determination, and compliance to 40 CFR 261 for leachable heavy metals content.

COMPOSITION (Percentage by Weight)		
Component	White	Yellow
Binder, ⁽¹⁾	18.0 min.	18.0 min.
Glass Beads (Premixed)	30 - 40	30 - 40
Titanium Dioxide	10.0 min.	—
Calcium Carbonate & Inert Fillers ⁽²⁾	42.0 max.	50.0 max.
Heavy Metals Content	Comply with 40 CFR 261	Comply with 40 CFR 261

⁽¹⁾Use a binder that consists of a mixture of synthetic resins, at least one being solid at room temperature, and high boiling point plasticizers. Ensure that at least one-third of the binder composition is solid maleic-modified glycerol ester resin and is not less than 8 percent by weight of the entire material formulation. Do not use alkyd binder that contains petroleum based hydrocarbon resins.

⁽²⁾The manufacturer may choose the amount of calcium carbonate and inert fillers, providing all other requirements of this section are met.

837.03.02 Physical Characteristics. For thermoplastic material heated for 4 hours at 425°F under agitation, conform to the following requirements.

- A) **Color.** As determined with a spectrophotometer using D65 illuminant with a 45 degree entrance angle and 0 degree observation angle geometry.

CIELAB Color Coordinates		
	Yellow	White
Daytime Color (CIELAB) Spectrophotometer using illuminant D65 at 45° illumination and 0° viewing with a 2° observer	L* 81.76 a* 19.79 b* 89.89 Maximum allowable variation 6.0ΔE*	L* 93.51 a* -1.01 b* 0.70 Maximum allowable variation 6.0ΔE*
Nighttime Color (CIELAB) Spectrophotometer using illuminant A at 45° illumination and 0° viewing with a 2° observer	L* 86.90 a* 24.80 b* 95.45 Maximum allowable variation 6.0ΔE*	L* 93.45 a* -0.79 b* 0.43 Maximum allowable variation 6.0ΔE*

- B) Flowability.** Ensure that the white thermoplastic material has a maximum residue of 18 percent and the yellow thermoplastic material has a maximum residue of 21 percent.
- C) Set Time.** Use material that, when applied at a temperature range of 415 ± 15 °F and thickness of 40 to 120 mils, sets to bear traffic in not more than 2 minutes when the air and road surface temperature is approximately ≥ 50 ± 3 °F, and not more than 10 minutes when the air and road surface temperature is approximately < 50 ± 3 °F.
- D) Softening Point.** Ensure that the thermoplastic material has a softening point of 215 ± 15 °F.
- E) Bond Strength.** Ensure that the bond strength of the thermoplastic material to concrete exceeds 180 psi.
- F) Cracking Resistance at Low Temperature.** Ensure that the thermoplastic material shows no cracks when observed from a distance exceeding one foot.
- G) Impact Resistance.** Ensure the impact resistance of the thermoplastic material is a minimum of 1.13 joules.
- H) Flash Point.** Use thermoplastic material that has a flash point not less than 475 °F.

837.04 PACKAGING. Package thermoplastic material in suitable 50 pound containers to which the material shall not adhere during shipment or storage. Include a label stating that the thermoplastic material is to be maintained with a temperature range of 400 – 440°F during application. Provide the thermoplastic material in either block or granular form.

837.05 SHELF LIFE. Ensure that the thermoplastic material conforms to this section for a period of one year. Replace any thermoplastic material not conforming to the above requirements.

837.06 MANUFACTURER’S TESTING. Perform testing in accordance with AASHTO T-250 on a minimum of one composite sample per 10,000 pounds, or portion thereof, per lot of thermoplastic produced.

837.07 CERTIFICATION. Submit manufacturer’s certification stating conformance to the requirements of this section for each lot of extruded thermoplastic delivered for use on projects. Clearly state the manufacture, formulation identification, product name, color, date of manufacturer, lot number (s), expiration date, total quantity of lot produced, actual quantity of thermoplastic material represented, sampling method utilized to obtain the samples, and required manufacturer’s testing data for each composite sample tested to represent each lot produced.

837.08 ACCEPTANCE. The Department will accept extruded thermoplastic based on compliance of the manufacturer's certification and conformance of test results obtained by the Department to the requirements of this section.

SECTION 842 — PAVEMENT STRIPING PAINT

842.01 DESCRIPTION. This section covers quick-drying waterborne acrylic pavement striping paint for permanent applications.

842.02 GENERAL. Select waterborne acrylic paint that conforms to the composition requirements below. Provide independent analysis data and certification for each formulation stating the total concentration of each heavy metal present, the test method used for each determination, and compliance to 40 CFR 261 for leachable heavy metals content.

PAINT COMPOSITION		
Property and Test Method	Yellow	White
Daytime Color (CIELAB) Spectrophotometer using illuminant D65 at 45° illumination and 0° viewing with a 2° observer	L* 81.76 a* 19.79 b* 89.89 Maximum allowable variation 4.0ΔE*	L* 93.51 a* -1.01 b* 0.70 Maximum allowable variation 4.0ΔE*
Nighttime Color (CIELAB) Spectrophotometer using illuminant A at 45° illumination and 0° viewing with a 2° observer	L* 86.90 a* 24.80 b* 95.45 Maximum allowable variation 4.0ΔE*	L* 93.45 a* -0.79 b* 0.43 Maximum allowable variation 4.0ΔE*
Heavy Metals Content	Comply with 40 CFR 261	Comply with 40 CFR 261
TiO ₂ ASTM D 4764	NA	10% by wt. of pigment min.
VOC ASTM D 2369 and D 4017	1.25-lb/gal max.	1.25-lb/gal max.
Contrast Ratio (at 15 mils wft.)	0.97	0.99

842.03 MANUFACTURER'S TESTING. Perform testing for Daytime and Nighttime Color, Contrast Ratio, Titanium Dioxide (white paints) and Volatile Organic Content (VOC) on each lot of waterborne acrylic paint to be delivered for use on projects.

842.04 SAMPLING. The Department will obtain samples of waterborne acrylic paint for compliance testing to the requirements of this section in accordance with the Department's Materials Field Sampling Manual.

842.05 CERTIFICATION. Submit manufacturer's certification stating conformance to the requirements of this section for each shipment of waterborne acrylic paint delivered for use on projects. Clearly state the manufacturer, product name, product code, lot number(s), expiration date, color, sampling method, test results of manufacturer required testing, and quantity delivered.

842.06 ACCEPTANCE. The Department will accept waterborne acrylic paint based on compliance of the manufacturer's certification and conformance of test results obtained by the Department to the requirements of this section.

842.07 ACCEPTANCE PROCEDURES FOR NON-SPECIFICATION PAVEMENT STRIPING PAINT. When non-specification paint is inadvertently

incorporated into the work the Department will accept the material with a reduction in pay. The percentage deduction is cumulative based on its compositional properties, but will not exceed 60 percent. The Department will calculate the payment reduction on the unit bid price for the routes where the non-specification paint was used. Do not accept waterborne acrylic paint with a Daytime or Nighttime color variation greater than $6.0\Delta E^*$ or if the cumulative deduction exceeds 60 percent.

PAVEMENT STRIPING PAINT REDUCTION SCHEDULE					
Non-conforming Property	Color 4.1 ΔE^* to 6.0 ΔE^*	Heavy Metals	TiO ₂	VOC	Contrast
Reduction Rate	10%	60%	10%	60%	10%

SECTION 846 - DURABLE WATERBORNE PAINT

846.01 DESCRIPTION. This section covers quick-drying durable waterborne acrylic pavement striping paint for permanent applications. The paint shall be ready-mixed, one-component, 100% waterborne acrylic striping paint suitable for application on such traffic-bearing surfaces as Portland cement concrete, bituminous cement concrete, asphalt, tar, and previously painted areas of these surfaces.

846.02 GENERAL. Select durable waterborne acrylic paint that conforms to the composition requirements below. Provide independent analysis data and certification for each formulation stating the total concentration of each heavy metal present, the test method used for each determination, and compliance to 40 CFR 261 for leachable heavy metals content.

The non-volatile portion of the vehicle shall be composed of a 100% acrylic polymer as determined by infrared spectral analysis. The acrylic resin used shall be a 100% cross-linking acrylic as evidenced by infrared peaks at wavelengths 1568, 1624, and 1672 cm-1 with intensities equal to those produced by an acrylic resin known to be 100% cross-linking.

PAINT COMPOSITION		
Property and Test Method	Yellow	White
Daytime Color (CIELAB) Spectrophotometer using illuminant D65 at 45° illumination and 0° viewing with a 2° observer	L* 81.76 a* 19.79 b* 89.89 Maximum allowable variation 4.0ΔE*	L* 93.51 a* -1.01 b* 0.70 Maximum allowable variation 4.0ΔE*
Nighttime Color (CIELAB) Spectrophotometer using illuminant A at 45° illumination and 0° viewing with a 2° observer	L* 86.90 a* 24.80 b* 95.45 Maximum allowable variation 4.0ΔE*	L* 93.45 a* -0.79 b* 0.43 Maximum allowable variation 4.0ΔE*
Heavy Metals Content	Comply with 40 CFR 261	Comply with 40 CFR 261
Titanium Dioxide ASTM D 4764	NA	10% by weight of pigment min.
VOC ASTM D 2369 and D 4017	1.25 lb/gal max.	1.25 lb/gal max.
Contrast Ratio (at 15 mils wft)	0.97	0.99

846.03 MANUFACTURER'S TESTING. Perform testing for Daytime and Nighttime Color, Contrast Ratio, Titanium Dioxide (white paints) and Volatile Organic Content (VOC) on each lot of durable waterborne acrylic paint to be delivered for use on projects.

846.04 SAMPLING. The Department will obtain samples of durable waterborne acrylic paint for compliance testing to the requirements of this section in accordance with the Department's Field Sampling and Testing Manual.

846.05 CERTIFICATION. Submit manufacturer's certification stating conformance

to the requirements of this section for each shipment of durable waterborne acrylic paint deliverer for use on projects. Clearly state the manufacturer, product name, product code, color, sampling method, test results of manufacturer required testing, and quantity delivered.

846.06 ACCEPTANCE. The Department will accept durable waterborne acrylic paint based on compliance of the manufacturer's certification and conformance of test results obtained by the Department to the requirements of this section.

846.07 ACCEPTANCE PROCEDURES FOR NON-SPECIFICATION DURABLE WATERBORNE PAVEMENT STRIPING PAINT. When non-specification paint is inadvertently incorporated into the work the Department will accept the material with a reduction in pay. The percentage deduction is cumulative based on its compositional properties, but will not exceed 60 percent. The Department will calculate the payment reduction on the unit bid price for the routes where the non-specification paint was used. Do not accept waterborne acrylic paint with a Daytime or Nighttime color variation greater than 6.0ΔE*.

DURABLE WATERBORNE PAVEMENT STRIPING PAINT REDUCTION SCHEDULE						
Non-conforming Property	Resin	Color 4.1ΔE* to 6.0ΔE*	Contrast	TiO ₂	VOC	Heavy Metals Content
Reduction Rate	60%	10%	10%	10%	60%	60%

KENTUCKY METHODS









Kentucky Method 201: Intersection Markings

180 day proving period

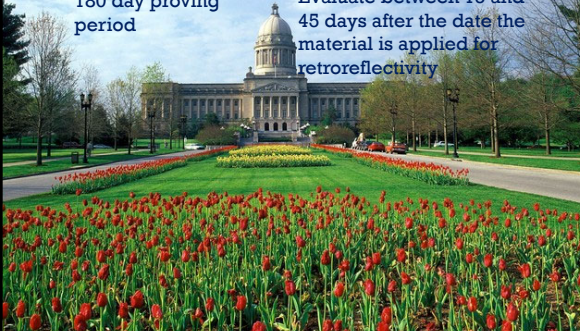
Evaluate between 15 and 45 days after the date the material is applied for retroreflectivity



Kentucky Method 201: Intersection Markings



- Perform visual inspections and bond checks
- Perform retroreflectivity tests at each intersection

- Each marking is considered separately
- Evaluate two markings per intersection
- Take two readings on each marking

KM201: Intersection Markings



Performance Requirements

If all readings meet or exceed the minimum requirements markings are accepted

White = 300 mcd/m²/lux
Yellow = 225 mcd/m²/lux

If any reading fails to meet the minimum requirements additional readings will be taken.

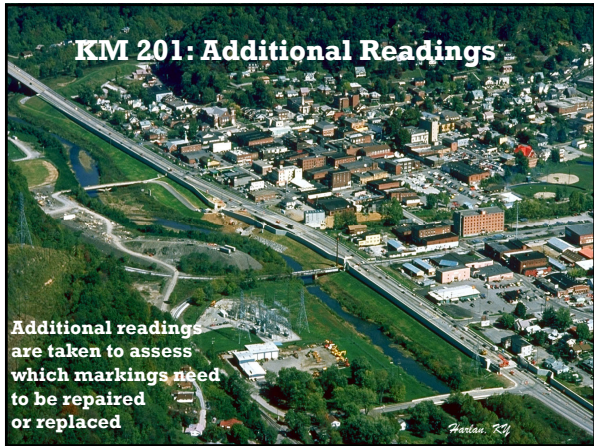

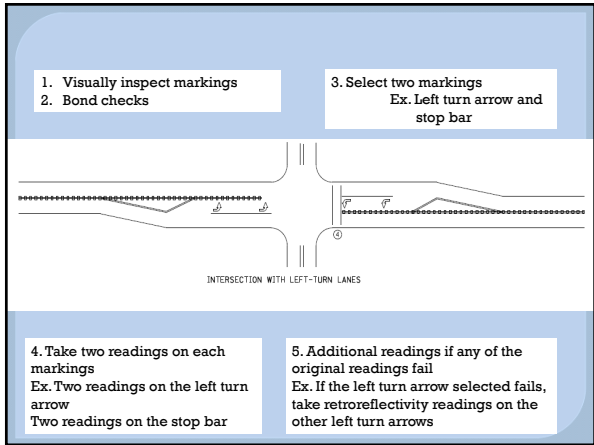

KM201: Intersection Markings Reporting

•Printout

•Date and time of application of the pavement markings (from contractor's DSR)

•Location (County, Intersection and marking)

TL-K S/N: #704
Calibrated: 154 (mcd/m²)/lx
User: BRPN
DN 23 2014 12 16 02 PM
Zero: 3 Scale: 10.88

TL-K S/N: #704
R1: 152 (mcd/m²)/lx
Prog: 221 #23/35
#28 MOB Y 11/20
DN 23 2014 12 17 18 PM
Status: 0

TL-K S/N: #704
R1: 323 (mcd/m²)/lx
Prog: 225 #23/35
#28 MOB Y 11/20
DN 23 2014 12 13 05 PM
Status: 0





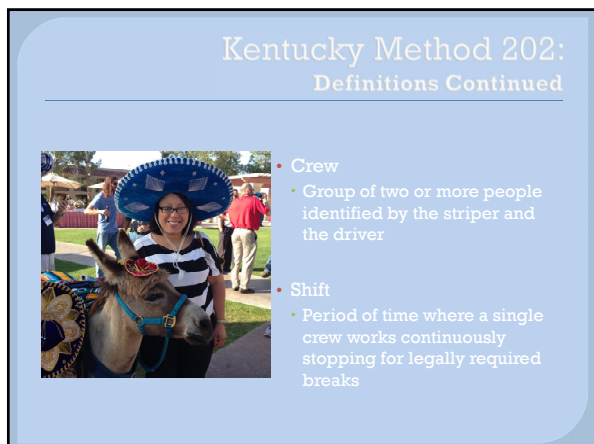

Kentucky Method 202: Handheld Inspection of Pavement Striping

Divide each section according to the striping completed

Section	Number of Segments Required
≥ 30 Miles	5 Segments
≥ 10 Miles and < 30 Miles	3 Segments
< 10 Miles	1 Segment

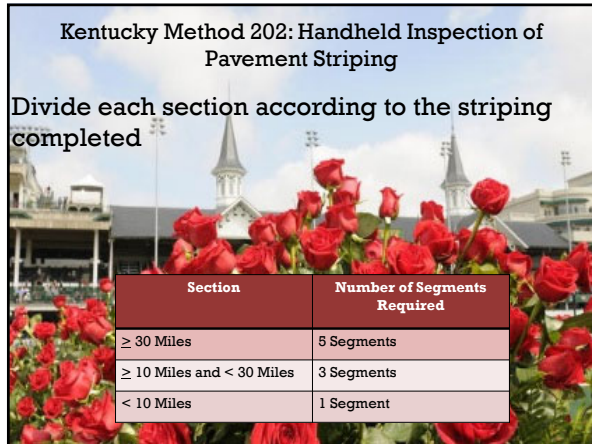

KM 202: Handheld Inspection of Pavement Markings
Establishing the Zone



KM202: Handheld Inspection of Pavement Markings
Establishing the Zone

- Randomly generate the starting point of a zone within each segment
 - Mark the beginning of each zone with spray paint
- Start each zone for the section at the same distance into each segment
- The starting point of the first zone is used to establish the location of the next zone within the next segment



**KM202: Handheld Inspection of Pavement Markings
Retroreflectivity Readings**



- Retroreflectivity readings are to be taken in the direction the striper applied the line
 - Take readings in both directions
 - Whichever direction gives you the higher reading, is the way the striper was headed when the line was applied

**KM 202:Handheld Inspection of Pavement Markings
Readings Within the Zone**

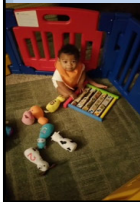

- Obtain 20 readings in each zone
 - Take the first reading at the beginning of the zone
 - Take subsequent readings at 15 foot intervals
 - For centerlines, alternate readings between the solid lines or on the combination of solid and skip lines
 - Measure each skip at two evenly spaced locations

**KM 202: Handheld Inspection of Pavement Markings
Moving the Zone**



Kentucky State Fruit. Blackberry
Credit: United States Department of Agriculture (USDA)

- Move the zone if any portion is unsafe
- Change in starting point of one zone should not change the starting point for the next zone
- Move ahead within the zone if readings cannot be taken due to
 - Potholes
 - Grass
 - Break in pavement
 - Debris

**KM 202: Handheld Inspection of Pavement Markings
Pass/Fail Segments**



If 80% or more of the readings within a zone pass, the segment passes.

If less than 80% of the readings pass, additional readings must be taken

White
301
312
325
432
368
298
312
313
338
287
278
304
317
291
315
325
303
314
291
326
Average 317.75

Bibb lettuce, America's first gourmet lettuce, developed by John Bibb of Frankfort, KY

**KM202: Handheld Inspection of Pavement Markings
Additional Readings**

*Happy birthday to you,
Happy birthday to you,
Happy birthday dear
[Pavement Markings Inspection Technician participants]
Happy birthday to you.*

- Establish two additional zones within the segment
- Take twenty readings in each of the two additional zones
- If 80% or more of all readings in the segment pass, the segment passes

By Patty and Mildred Hill of Louisville, KY

**Kentucky Method 202: Handheld Inspection of Pavement Markings
Exception**



If 13 or more of the readings in the first zone in a segment fail, additional readings are unnecessary

The segment fails

KM202: Handheld Inspection of Pavement Markings
Pass/Fail Section

- 3 segments fail (section > 30 miles)
 - The section is not accepted
- 1 segment fails (section < 30 miles)
 - The section is not accepted



KM 202: Handheld Inspection of Pavement Markings
Reporting

•Printout •Date and Time of Application •Location of Test



Kentucky Method 203



Evaluation of
 Retroreflectivity on
 Permanent Markings
 Using Mobile
 30 Meter Geometry
 Instruments

KM 203: Mobile Evaluation of Pavement Markings

Definitions

- **Section**
 - Portion of striping completed for a single color per line width by one striping crew in one shift
- **Segment**
 - Portion equal to one-tenth of a mile of a section
 - Segment is 528 feet

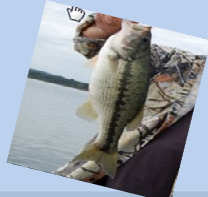

KM 203: Mobile Evaluation of Pavement Markings

Definitions Cont.

- **Crew**
 - Two or more people identified by the truck and driver applying pavement markings
- **Shift**
 - Period of time where a single crew works continuously



KM 203: Mobile Inspection of Pavement Markings

Evaluation



- At least 50% of all segments in each section will be evaluated by the mobile
- The mobile will pass/fail sections
- Readings will be taken in the direction the striping crew applied the line

KM 203: Mobile Evaluation of Pavement Markings
Pass/Fail Criteria

- ◉ If
 - 80% or more of the segments for a section pass, the section passes
- ◉ If
 - Less than 80% of the segments pass, the section will not be accepted



KM 203: Mobile Evaluation of Pavement Markings
Reporting

- 
- ◉ **Mobile Readings**
 - Date and time of test
 - Calibration Information
 - % Passing
 - ◉ **Date and Time of Application**
 - From mobile request form
 - ◉ **Location of Test**

EVALUATION OF RETROREFLECTIVITY ON INTERSECTION PAVEMENT
MARKINGS USING PORTABLE HAND-OPERATED INSTRUMENTS

1. SCOPE:
 - 1.1. This method covers the evaluation of retroreflectivity on pavement markings using portable hand-operated instruments.
 - 1.2. It is intended to provide standards of intersection pavement markings to assure that adequate retroreflectivity for the driver is provided by newly applied markings.
 - 1.3. Thermoplastic intersection pavement markings will be evaluated in a period of not less than 15 to no more than 45 days after the date the materials are applied.
2. TERMINOLOGY: Retroreflectivity: a standard of measure for pavement markings. The units for these readings are millicandelas per square meter per lux ($\text{mcd}/\text{m}^2/\text{lx}$).
3. SUMMARY OF SPECIFICATION:
 - 3.1. Perform a visual inspection and bond checks for each marking.
 - 3.2. Perform retroreflectivity tests at each intersection on at least 2 markings.
 - 3.3. For the purpose of evaluating retroreflectivity, each marking will be considered separately with 2 readings taken on each marking evaluated. Readings will not be taken on portions of the marking that are in the wheel track or where build up of road debris such as oil, grease, etc. would provide readings not representative of the quality of the work.
4. PERFORMANCE REQUIREMENTS:
 - 4.1. Retroreflectivity: The pavement marking will be evaluated for acceptance within the time period detailed in section 1.3.
 - 4.2. If all four readings taken in an intersection meet or exceed the required minimum retroreflectivity values established for the materials that are being measured, the intersection markings that are being evaluated will be accepted.
 - 4.3. If any of the readings taken in an intersection are below the required minimum retroreflectivity values established for the materials that are being measured, additional readings will be taken within the intersection that is being evaluated.
 - 4.4. Taking additional readings: At the discretion of the engineer, additional readings may be taken to assess which markings within an intersection need to be replaced or repaired.

5. REPORTING:

5.1. Include the following in the inspection report:

5.1.1. Printout of the readings taken with the hand-operated instrument (which should show date and time of test and zero reading and calibration).

5.1.2. Date and time of application of the pavement marking from the Contractors Daily Report.

5.1.3. Location (County, intersection, marking tested and any special information).

5.2. Readings shall be recorded in millicandelas per square meter per lux (mcd/m²/lx).

5.3. Measurement shall be reported for each intersection of markings per day.

APPROVED



DIRECTOR
DIVISION OF MATERIALS

DATE

02/04/08

Kentucky Method 64-201-08
Dated 02/04/08
Supersedes KM 64-201-03
Dated 02/05/03

EVALUATION OF RETROREFLECTIVITY ON PAVEMENT MARKINGS USING PORTABLE HAND-OPERATED INSTRUMENTS

1. SCOPE:

- 1.1. This method covers the evaluation of retroreflectivity on pavement markings using portable hand-operated 30-meter geometry instruments.
- 1.2. It is intended to provide standards of horizontal pavement markings to assure that adequate retroreflectivity for the driver is provided by newly applied markings.
- 1.3. Waterborne and durable waterborne pavement markings will be evaluated in a period of not less than 30 to no more than 60 days after the date the materials are applied.
- 1.4. Durable pavement markings such as Thermoplastic, Permanent Pavement Tapes, and Epoxies will be evaluated in a period of time not less than 150 days to no more than 210 days after the date the materials are applied.

2. TERMINOLOGY:

- 2.1. Section: a portion of striping completed for a single color per line width by one striping crew in one shift.
- 2.2. Segment: a portion equal to one fifth (or more) of a section.
- 2.3. Zone: a location in each segment where one begins taking retroreflectivity readings.
- 2.4. Retroreflectivity: a standard of measure for pavement markings. The units for these readings are millicandelas per square meter per lux ($\text{mcd}/\text{m}^2/\text{lx}$).
- 2.5. Crew: a group of two or more people identified by the striper and the driver of the striper applying pavement markings.
- 2.6. Shift: a period of time whereby a single crew works continuously stopping only for legally required breaks

3. SUMMARY OF SPECIFICATION:

- 3.1. For the purpose of evaluating retroreflectivity, each section will be evaluated separately. Divide each section into segments containing a zone (as shown in [Figure 1A](#), [Figure 1B](#), [Figure 1C](#), and as described in Step 3.2). Establish five segments to collect readings to represent a day's striping if the total day's striping is ≥ 30 miles. Establish three segments to collect readings to represent a day's striping if the total day's striping is ≥ 10 miles and

<30 miles. If the total day's striping is <10 miles the day will be considered one segment.

Figure 1A. Striping Day (≥ 30 miles)

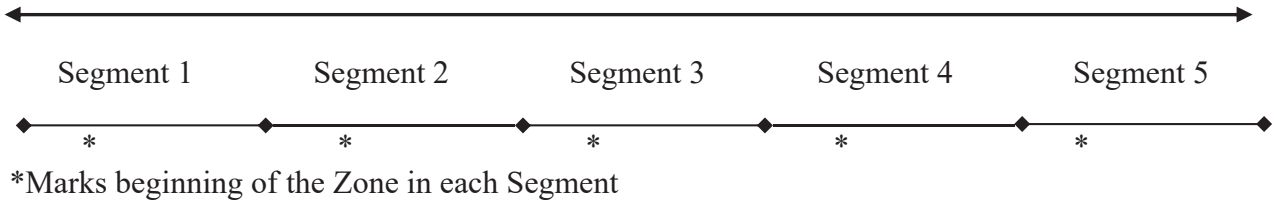

Figure 1B. Striping Day (≥ 10 miles and < 30 miles)

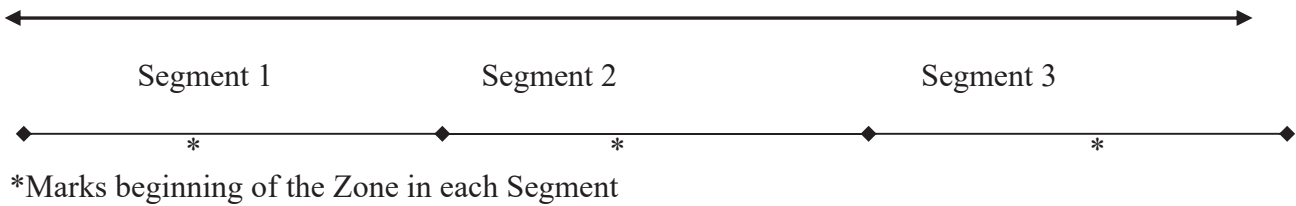
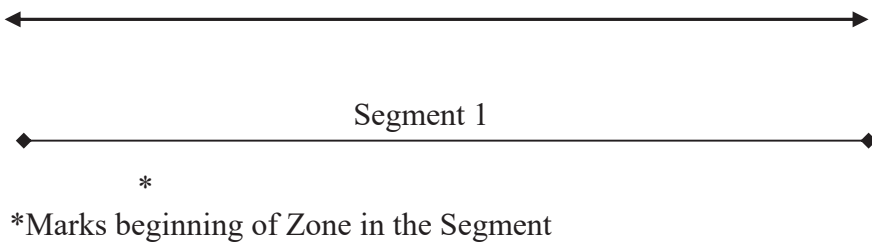
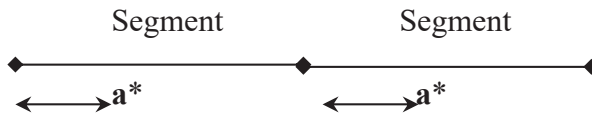

Figure 1C. Striping Day (< 10 miles)



- 3.2. As stated in Step 3.1, divide the number of miles striped in a day to establish the length of each segment. In the first segment, randomly generate a milepoint (to the nearest tenth of a mile) to begin taking readings in the first zone. The distance from the beginning of the segment to the beginning of the zone (distance a^*), in the first zone, will be used to establish the location of each successive zone within successive segments (See [Figure 2](#)).

Figure 2.



NOTE: a^* =distance each time, from beginning of each segment, to beginning of zone.

- 3.3. Mark the beginning and ending point of each zone with spray paint. Make sure the calibration transfer is not more than one week old. Perform a daily calibration on the hand-operated instrument according to the manufacturer's instructions. Print the calibration readings at the beginning of each days work. Recalibrate the instrument every 2 hours when taking continuous readings or before taking readings if the instrument has not been used for 30 minutes or more. Print the calibration readings each time these operations are performed.
 - 3.4. Take 20 readings in each of the zones in the direction the striper applied the traffic markings. Take the first reading exactly at the beginning of the zone. Take subsequent readings at approximately 15-foot intervals (5 paces). If any portion of the zone is unsafe for taking readings, move forward to the first point which can be inspected safely and begin the zone there. Do not move the zone simply for convenience. A change in the starting point of one zone should not change the starting points of any subsequent zones. Also, if a valid reading is not attainable at a location within the zone due to a pothole, grass, occasional tracking, etc., move forward in the zone to the first available location for a valid reading, then resume the subsequent readings within that zone in the incremental procedure described above. However, readings will be taken in areas with substantial amounts of tracking.
 - 3.5. For readings taken on centerlines, take alternating readings between solid lines or on the combination of solid and skip lines.
 - 3.6. When a zone contains only skip lines for evaluation, measure each skip line at two evenly spaced locations on the line. Continue measuring within the established zone in this manner until 20 readings are obtained.
 - 3.7. When a zone contains multiple line types of the same color and width, i.e. edgeline and lane line, obtain measurements representative of the quantities of line types.
4. PERFORMANCE REQUIREMENTS:
- 4.1. Retroreflectivity: The pavement marking will be evaluated for acceptance within the time period detailed in [sections 1.3 and 1.4](#).
 - 4.2. If 80% (16 or more) of the readings in a zone meet or exceed the required minimum retroreflectivity values established for the materials that are being measured, the segment that is being evaluated will be accepted.
 - 4.3. If less than 80% (less than 16) of the readings in a zone meet the required minimum retroreflectivity values established for the materials that are being measured, additional

readings will be taken within the segment that is being evaluated.

- 4.4. Taking additional readings - Randomly establish two (2) new zones within the segment in question using the procedure detailed in section 3.2. Obtain readings for each of these zones as described in 3.2 –3.4. These readings will be combined with the initial readings for evaluation of the segment. If less than 80% of the 60 readings (20 in each of three zones) taken within a segment meet the minimum retroreflectivity requirements established for the materials that are being measured, the segment is not accepted. Alternatively, if 13 or more of the first 20 readings taken within a segment fail to meet the minimum retroreflectivity requirements established for the materials that are being measured, the segment is not accepted and additional testing within that segment is not required.
- 4.5. If three of five segments are not accepted on a section of striping that is ≥ 30 miles in length, the entire section of striping will not be accepted. If one segment is not accepted on a section of striping that is <30 miles in length, the entire section of striping will not be accepted.

5. REPORTING:

- 5.1. Include the following in the inspection report:
 - 5.1.1. Printout of the readings taken with the hand-operated instrument (which should show date and time of test and zero reading and calibration)
 - 5.1.2. Date and time of application of the pavement marking from the Contractors Daily Striping Report
 - 5.1.3. Location (County, route, milepoint, intersection, direction of travel, color of line, line type and any special information)
- 5.2. Record readings in millicandelas per square meter per lux (mcd/m²/lx).
- 5.3. Report measurements for each section of striping per color per line width per shift.

APPROVED

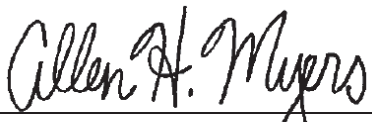

DIRECTOR
DIVISION OF MATERIALS

DATE

01/24/12

Kentucky Method 64-202-12
Revised 01/20/12
Supersedes KM 64-202-10
Dated 01/15/10

EVALUATION OF RETROREFLECTIVITY ON PERMANENT PAVEMENT MARKINGS USING MOBILE 30 METER GEOMETRY INSTRUMENTS

1. SCOPE:

- 1.1. This method covers the evaluation of retroreflectivity on permanent pavement markings using mobile 30-meter geometry instruments.
- 1.2. It is intended to provide standards of horizontal pavement markings to assure that adequate retroreflectivity for the driver is provided by newly applied markings.
- 1.3. Waterborne and durable waterborne pavement markings will be evaluated in a period of not less than 30 to no more than 60 days after the date the materials are applied.
- 1.4. Durable pavement markings such as Thermoplastic, Permanent Pavement Tapes, and Epoxies will be evaluated in a period of time not less than 150 days to no more than 210 days after the date the materials are applied.

2. TERMINOLOGY:

- 2.1. Section: a portion of striping completed for a single color per line width by one striping crew in one shift.
- 2.2. Segment: a portion equal to one-tenth of a mile of a section.
- 2.3. Retroreflectivity: a standard of measure for pavement markings. The units for these readings are millicandelas per square meter per lux ($\text{mcd}/\text{m}^2/\text{lx}$).
- 2.4. Crew: a group of two or more people identified by the striper and the driver of the striper applying pavement markings.
- 2.5. Shift: a period of time whereby a single crew works continuously stopping only for legally required breaks.

3. SUMMARY OF SPECIFICATION:

- 3.1. For the purpose of evaluating retroreflectivity, data obtained through evaluation according to KM 64-203 will be collected and evaluated separately for each section.
- 3.2. Calibrate the mobile instrument. Record calibration measurements at the beginning of the day's work. Recalibrate the instrument as necessary when taking readings. Provide the calibration measurements in the retroreflectivity report, each time these operations are performed.

3.3. The Department will provide the Contractor operating the mobile retroreflector with routes for evaluation. The routes evaluated will represent at least 50% of the segments completed in a section of striping. Data shall be collected in the direction the striper applied the traffic markings.

4. PERFORMANCE REQUIREMENTS:

4.1. Retroreflectivity: The pavement marking will be evaluated for acceptance within the time periods detailed in [sections 1.3. and 1.4.](#)

4.2. If 80% or more of the segments evaluated in a section meet or exceed the required minimum retroreflectivity values established for the materials that are being measured, the section will be accepted.

4.3. If less than 80% of the segments evaluated in a section meet the required minimum retroreflectivity values established for the materials that are being measured, the section will not be accepted.

5. REPORTING:

5.1. Include the following in the inspection report:

5.1.1. Calibration information for the mobile retroreflector.

5.1.2. Average of the readings taken for each segment evaluated by the mobile retroreflector (which should show date of test, total number of segments, passing segments, % passing segments, failing segments and % failing segments).

5.1.3. Date of application of the pavement marking.

5.1.4. Location (District, county, route, starting milepoint, ending milepoint, line type, direction of travel, color of line, and any special information).

5.2. Readings shall be recorded in millicandelas per square meter per lux ($\text{mcd}/\text{m}^2/\text{lx}$).

5.3. Measurement shall be reported for each section of striping per color per line width per shift.

APPROVED



DIRECTOR
DIVISION OF MATERIALS

DATE

01/24/12

Kentucky Method 64-203-12

Revised 01/20/12

Supersedes KM 64-203-10

Dated 01/15/10

KM 64-203-12

LTL-X OVERVIEW
AND
HANDS ON
DEMONSTRATION

Operational Training Overview



LTL-X

Retroreflectometer
for Pavement Markings



Regulatory Requirements



WHY? – Because Congress Said So

1993 – Congress direction for MUTCD language:
“The Secretary of Transportation shall revise the MUTCD to include a standard for a minimum level of retroreflectivity that must be maintained for traffic signs and pavement markings which apply to all roads open to public travel.”

Measuring Nighttime Visibility of Pavement Markings

“Inadequate and poorly maintained signs and markings are often cited as the contributing factor to accidents.

While only 25 percent of travel occurs at night, about 55 percent of the fatal accidents occur then.”

FHWA

Retroreflectivity: Raising the Nighttime
Brightness
Of Traffic Signs and Markings



Nighttime Visibility: The Real Problem

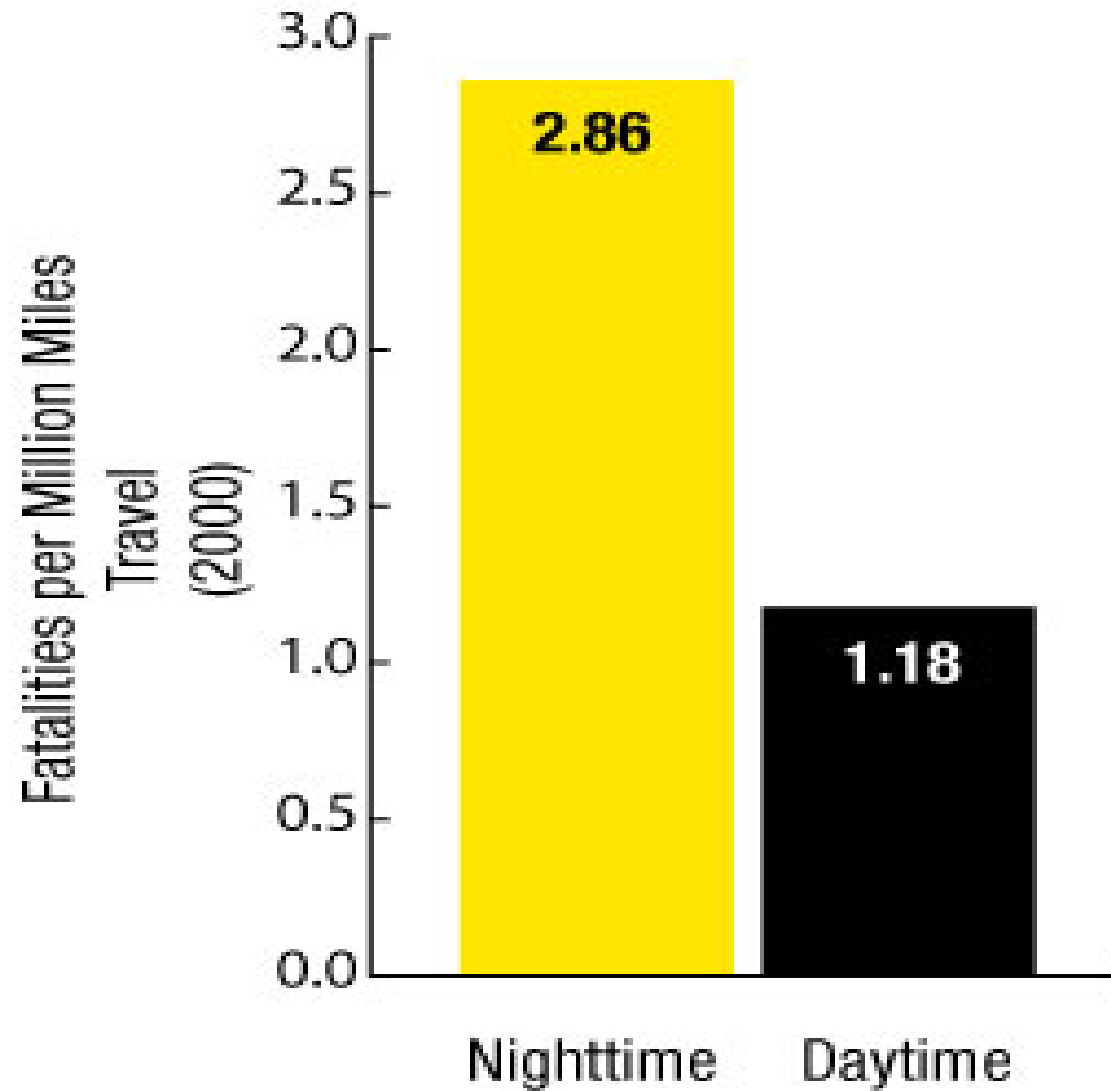

Nighttime vs Daytime Visibility Data

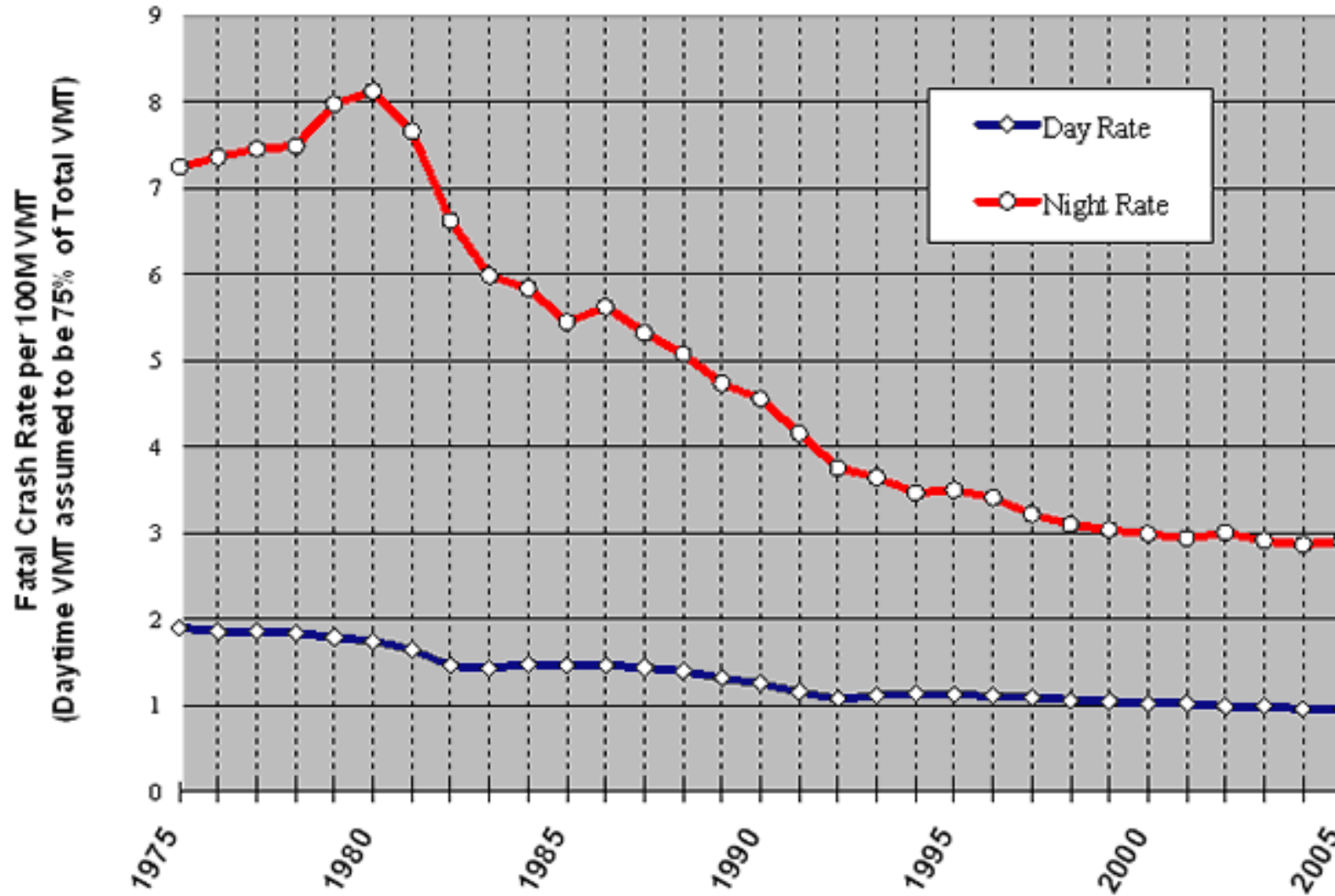

LTL-X Wet Retroreflectivity

ASTM E 2832

“...under conditions of continuous wetting”

ASTM E 2177

“...in conditions of wetness, such as after a period of rain.”



Measuring Retroreflectivity



Government agencies recognize the problems with subjectivity trying to evaluate pavement markings for nighttime visibility and color.

As a result, many agencies are setting numerical standards for retroreflectivity.

Types of Reflection



Mirror reflection

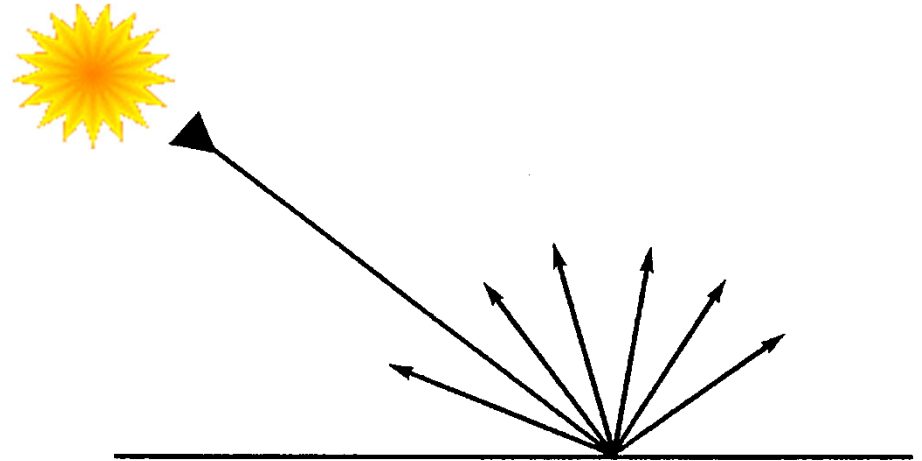

Diffuse reflection

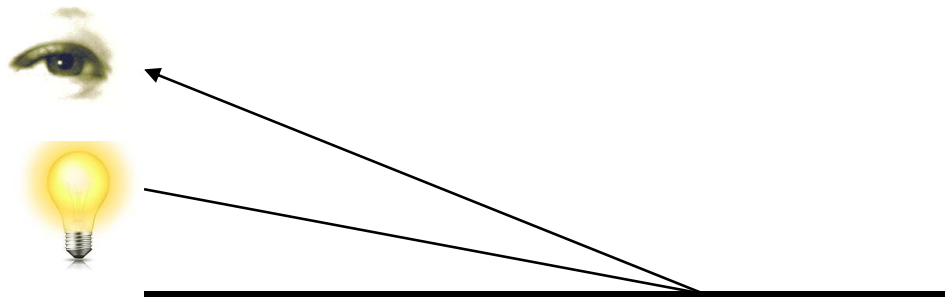

Retroreflection

What affects performance?

- Quality of material and application
- Embedment of glass beads
- Water on roadway
- Driver's eyesight
- Position and quality of headlamps
- Design of marking (profiled)
- Color of marking
- Road surface and debris

Glass Bead Embedment

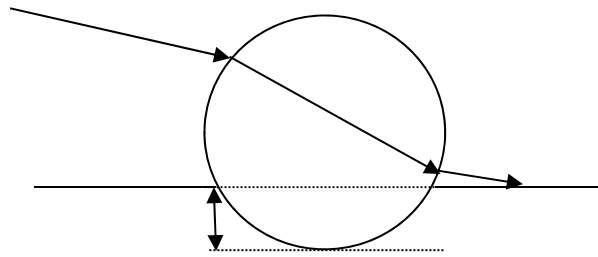

High Embedment, Poor

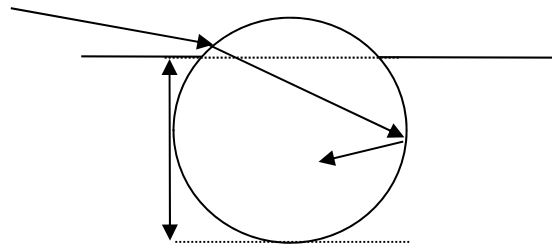

Low Embedment, Poor

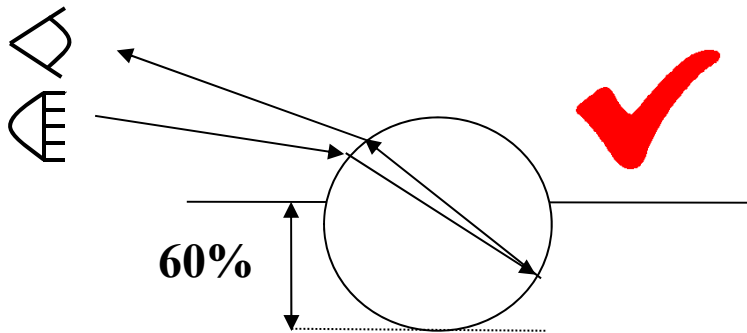

60% Embedment, Good

Effects of Water

Light is reflected away from glass bead by water.

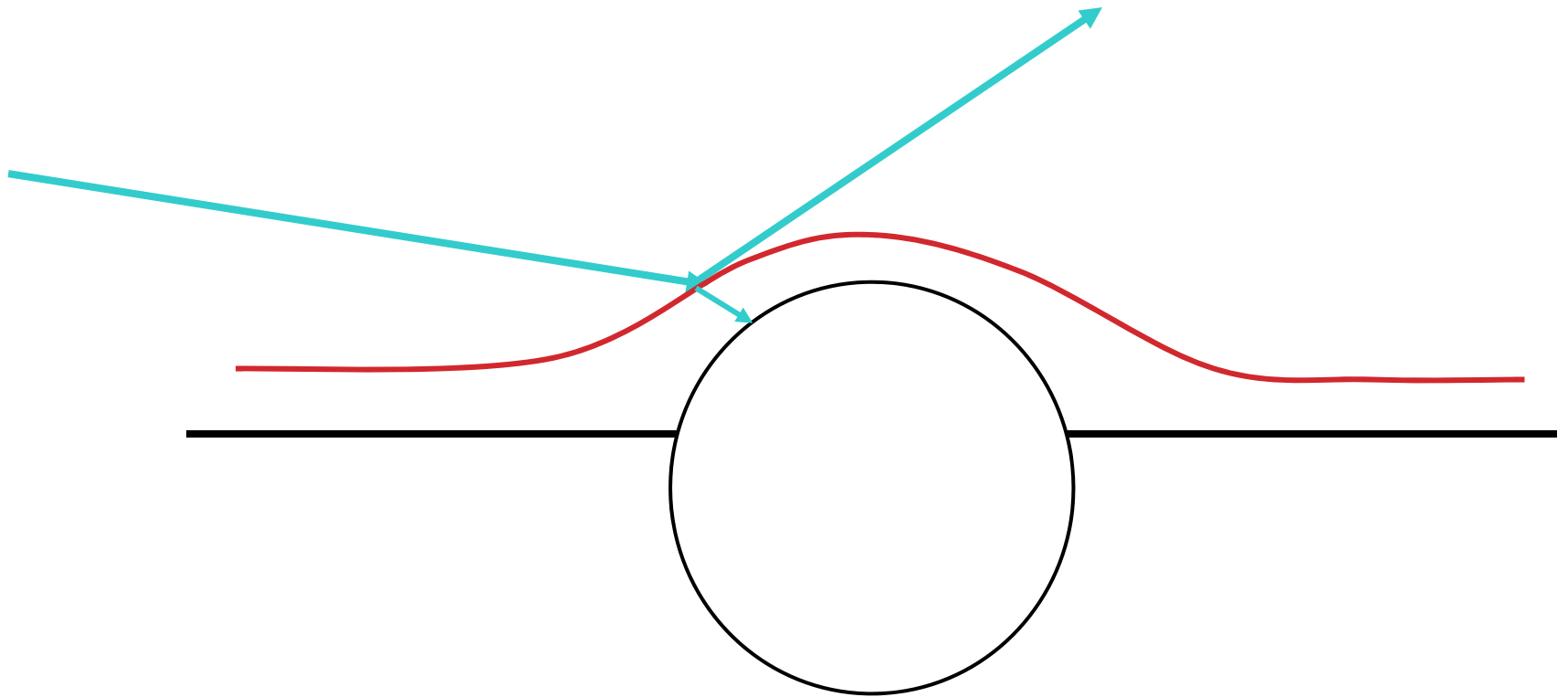

Retroreflection in a glass bead

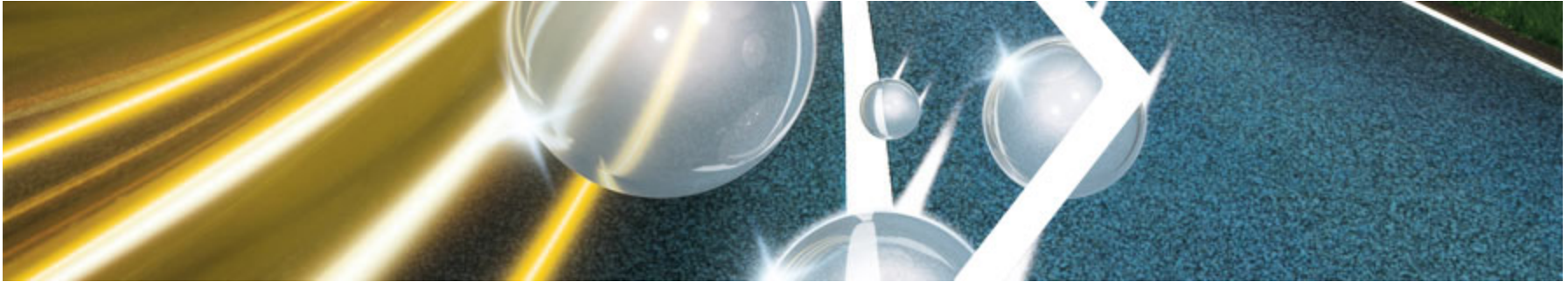

- Pavement markings have glass beads embedded in them to create retroreflection
- During the production of preformed markings
- Drop-on beads during the application
- The coefficient of retroreflection RL is used to characterize the retroreflection

Drivers Eyesight

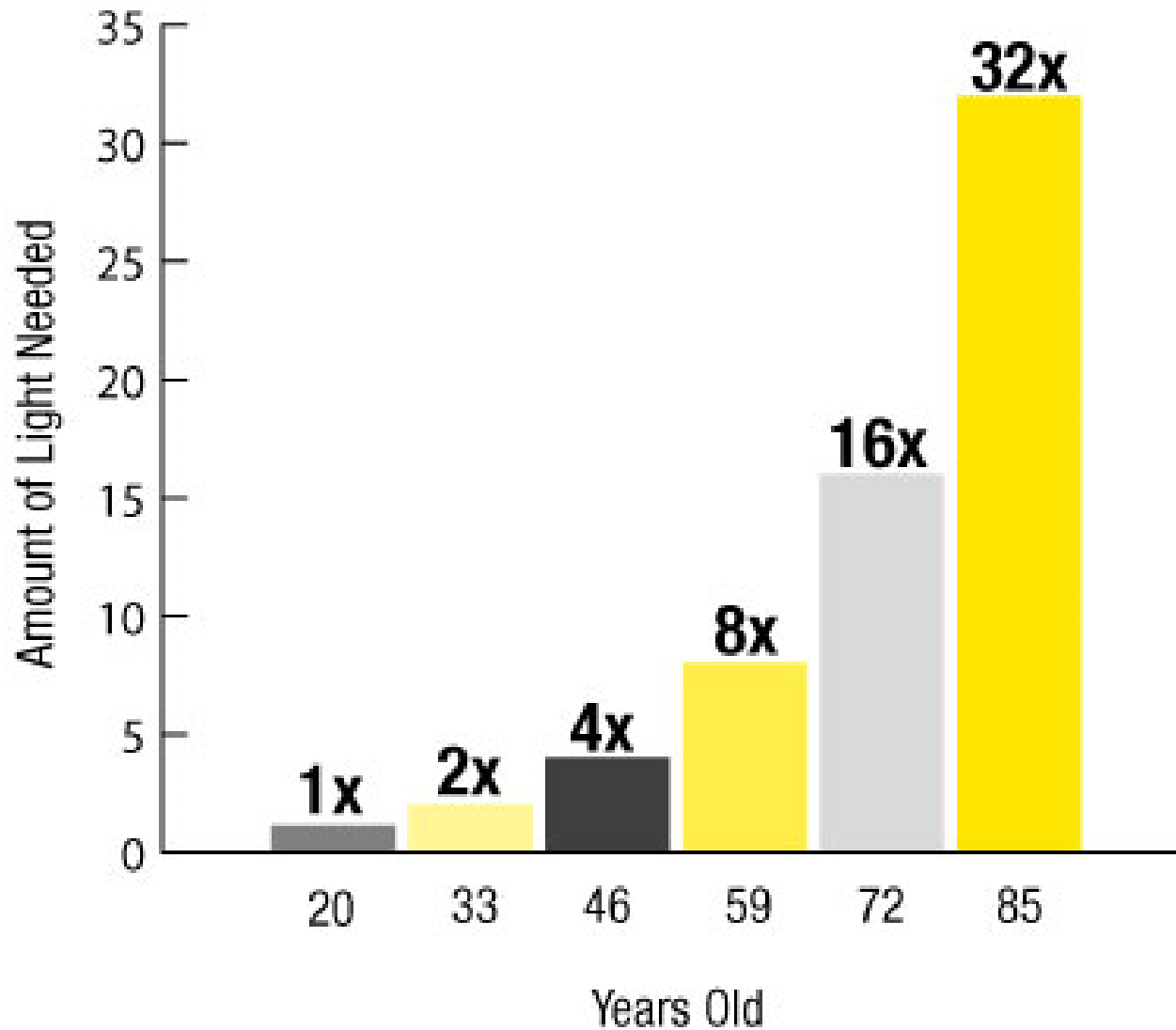

Reflectivity on Markings

How does it work?

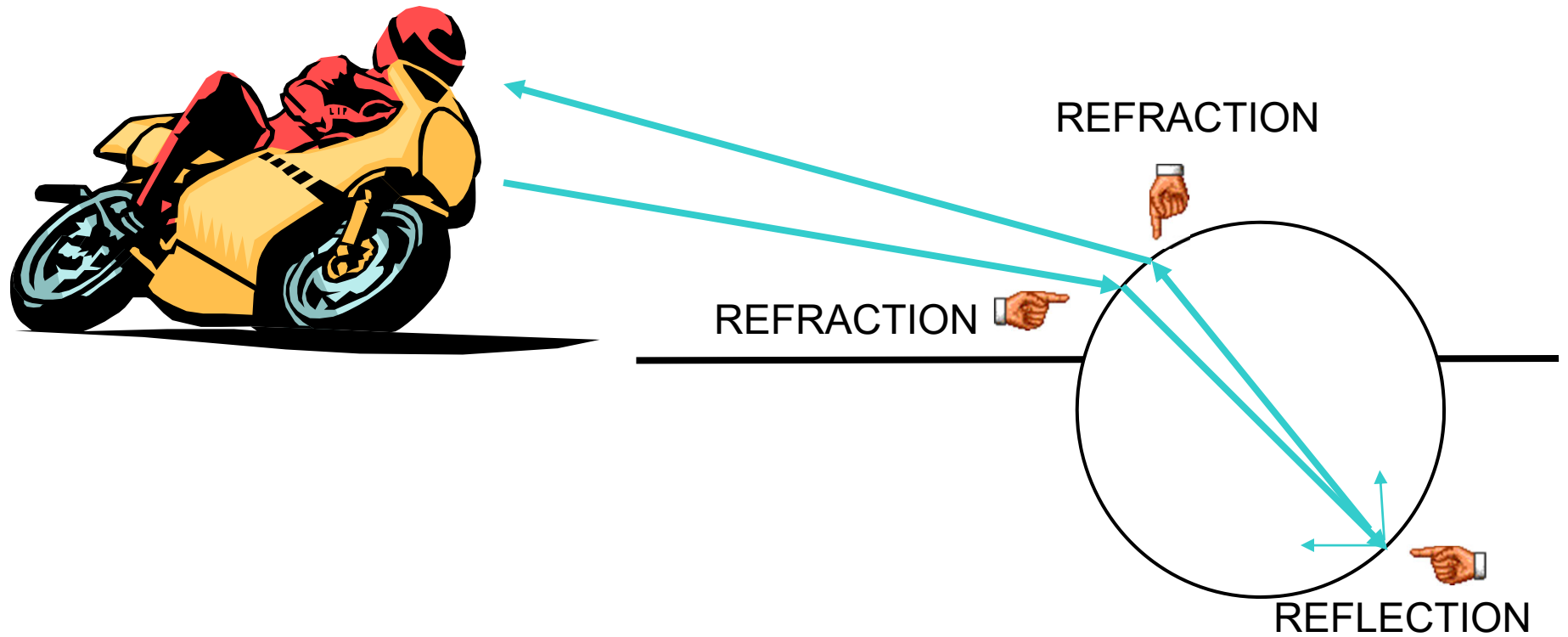

Angles for Pavement Markings

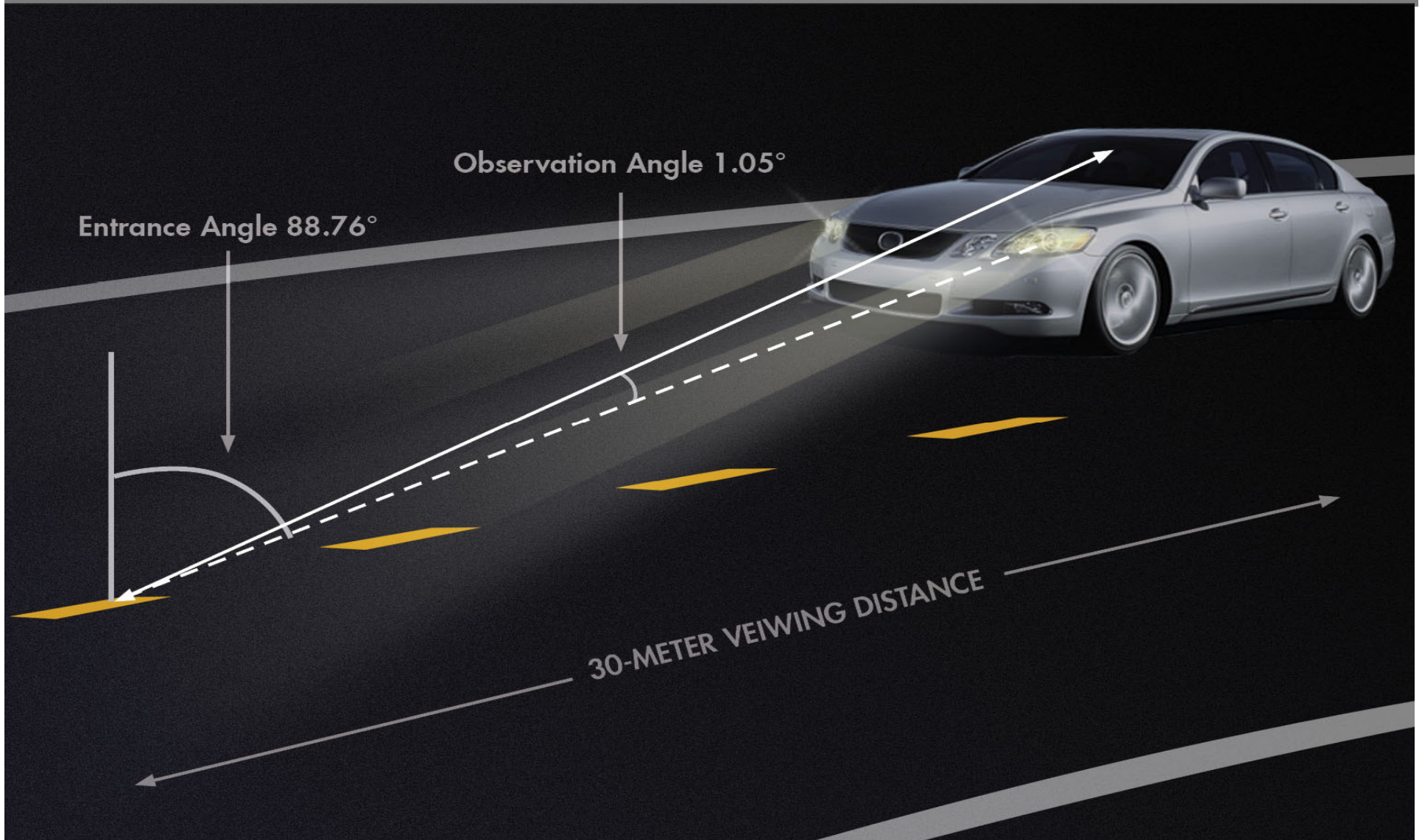

Angles for Pavement Markings

30-meter geometry

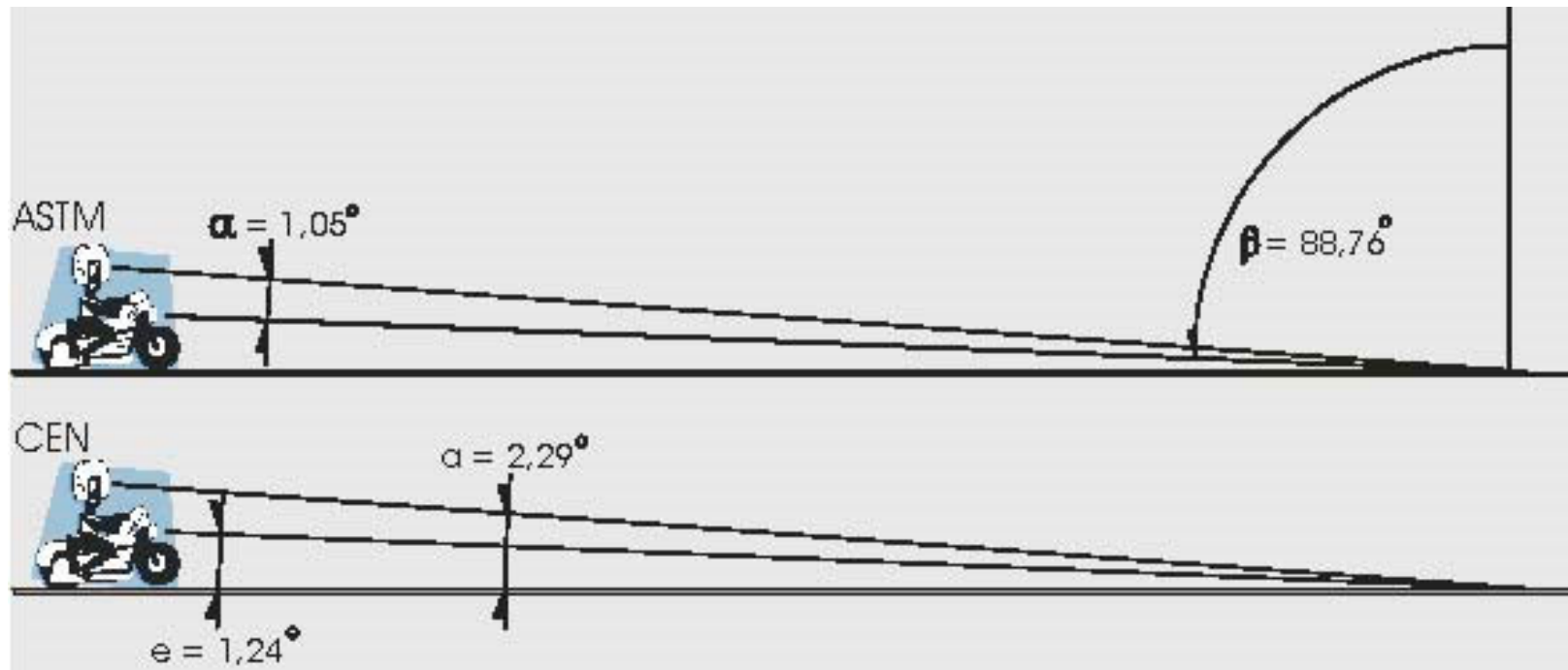

- ASTM= American Society for Testing and Materials
- CEN= European Committee for Standardization

What Do We USE

The reference instrument for qualification and asset management of pavement markings

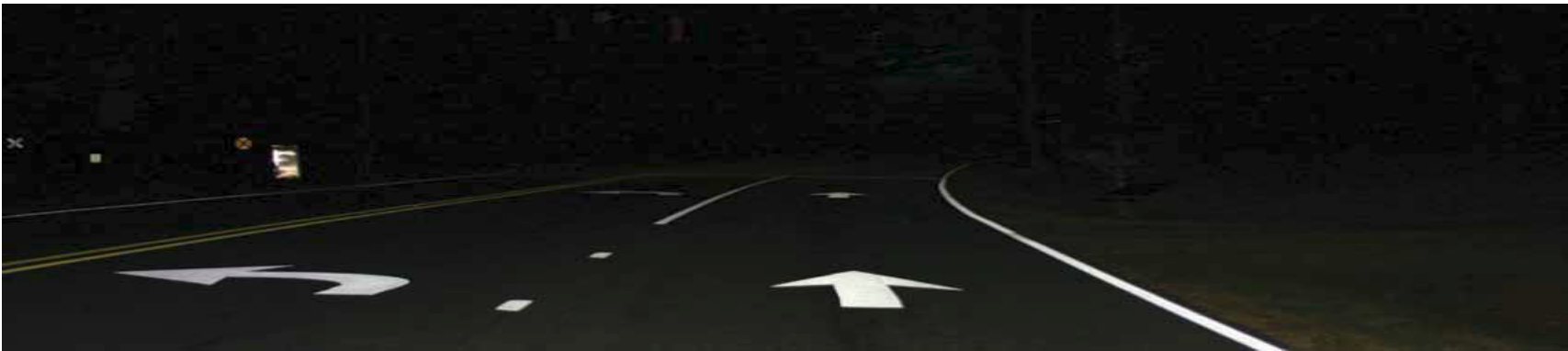

DELTA LTL-X



Retroreflectometer

LTL-X: Features

- Traceable and accredited calibrated reflection standard
- Operates using 30m Geometry
- Ergonomic operation height
- Fast measurement (approx. 1 sec)



LTL-X: Features

- Measure dry and wet surfaces
- Plane & profiled markings
- Built-in thermal printer
- GPS



LTL-X: Features

- Portable self-contained instrument
- Data storage, user identification and Series ID
- RSC PC software
- Easy calibration procedure



LTL-X: Features

- User-replaceable NiMH battery, charging time approx. **2 hour**
- Average, Fixed or Moving
- Multiple languages
- Wheel unit



LTL-X: Parts & Accessories

- LTL-X Unit
- Black calibration block
- Red field calibration block
- LTL-X Manual
- RSC2 Program CD
- Extra rolls of paper
- Communication cable
- Calibration labels
- Fuses and tools
- Wheel unit
- Wet Night Measurement Kit



Calibration Blocks

“Office Reference”
Black block in black box



“Field Reference”
Red block in grey box



Calibration Block Considerations

Do

- Store the **Black Block** properly inside its case within the office
- Store the **Red Field Block** properly inside its case when not in use



Don't

- Leave the calibration blocks outside of their storage compartments
- Touch the white ceramic area of the calibration blocks
- Bump edges of the calibration blocks, this could cause damage to the ceramic face
- Take the **Black Block** outside of the office



Environmental Considerations

Do

- Make sure the operating temperature is between 32 °F and 113°F
- The humidity should be between 0 and 90% and non-condensing
- Transport the instrument in a non-air-conditioned or non-heated area of your vehicle



Don't

- Use the instrument when moisture is condensing out of the air, such as early morning dew
- Use the instrument too soon after moving it from place to place where the temperature or humidity are very different without letting the instrument acclimate for 15 minutes out of its case



Pavement Marking Considerations

Do

- Make sure the markings are dry from application
- Make sure the markings are dry from moisture



Don't

- Take measurements on wet or damp markings
- Take measurements on markings with loose glass beads or debris on them



Control Panel

Help
Menu
Home
Back



On/Off
Smart
Calibrate
Print

Center Green
Button to take
measurements &
select options

Arrow buttons allows
you to move thru the
menu system and
highlight options

Home Screen Menu

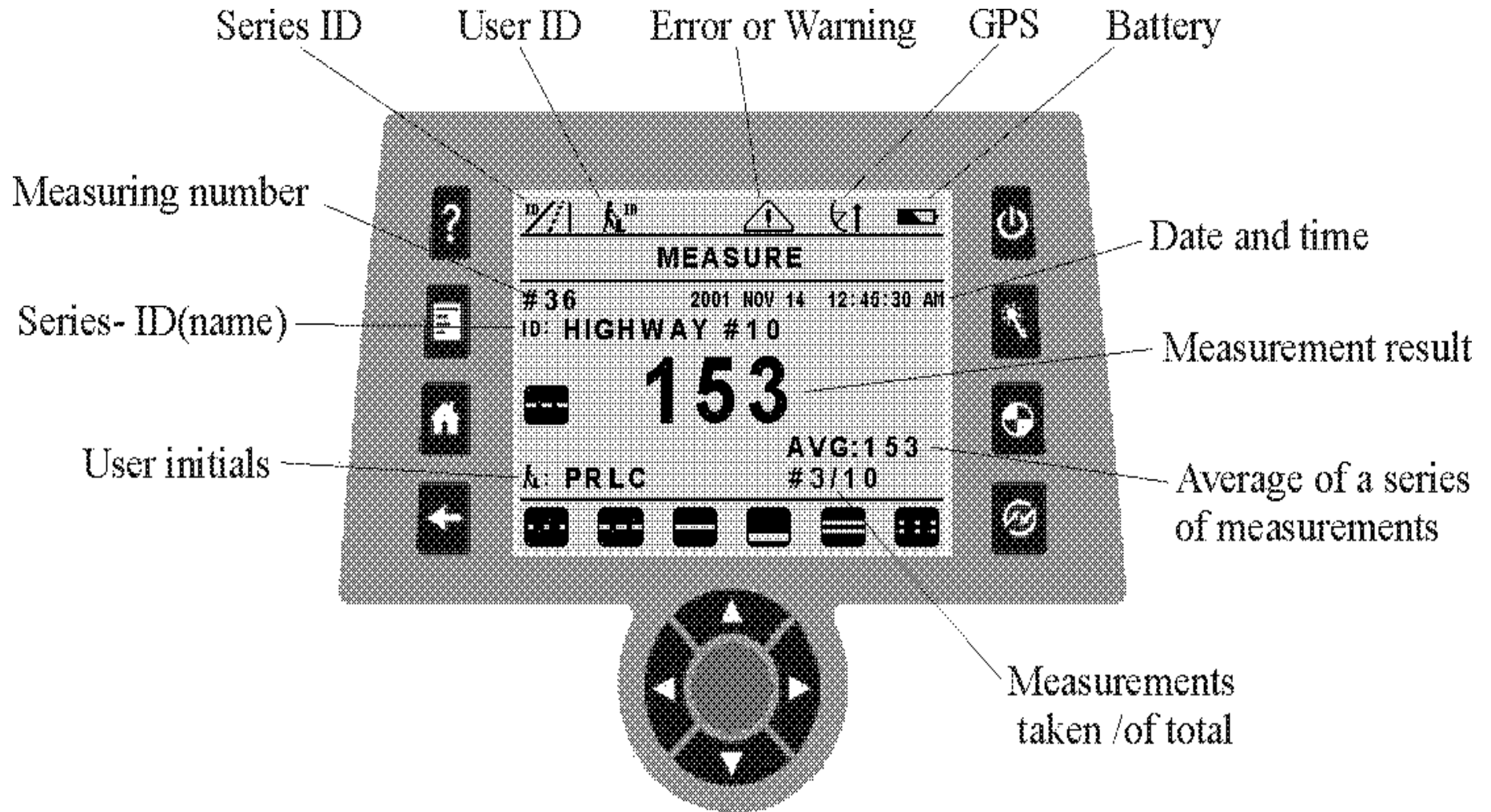

Menu Tree

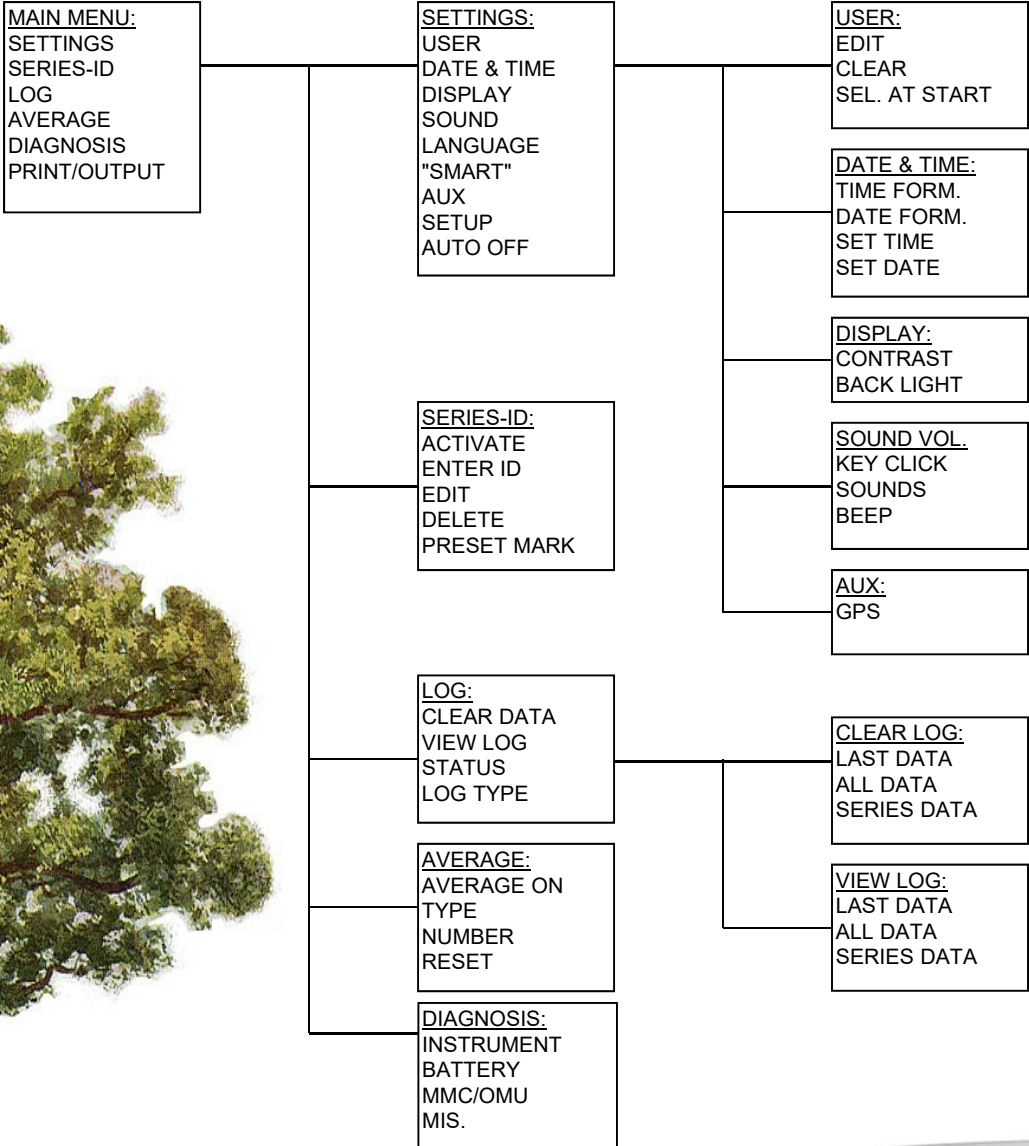

Main Menu Screen



When the user selects the Main Menu they have access to view information & edit options in the Instrument.

- Settings
- Series-ID
- Log
- Average
- Diagnosis
- Print/Output

Settings Menu



Allows the user to setup the LTL-X defaults settings.

- User
- Date & Time
- Display (Contrast/Back Light)
- Sound
- Language
- Smart
- Aux (turn GPS on/off)
- Setup
- Auto Off (Setting 60-300 sec)

User ID



The user ID is used to identify the operator and is saved in the log together with each measurement. It consists of up to four letters, If enabled, it can be seen at the lower left side of the measurement display. Measurements can also be taken without a user ID. 8 predefined user ID's can be setup.

Language Options



Smart Key



The Smart Key is programmable to one of several functions.

- Select Series
- Clear Last Measurement
- Reset Average
- Series ID ON/OFF

Aux: GPS Option

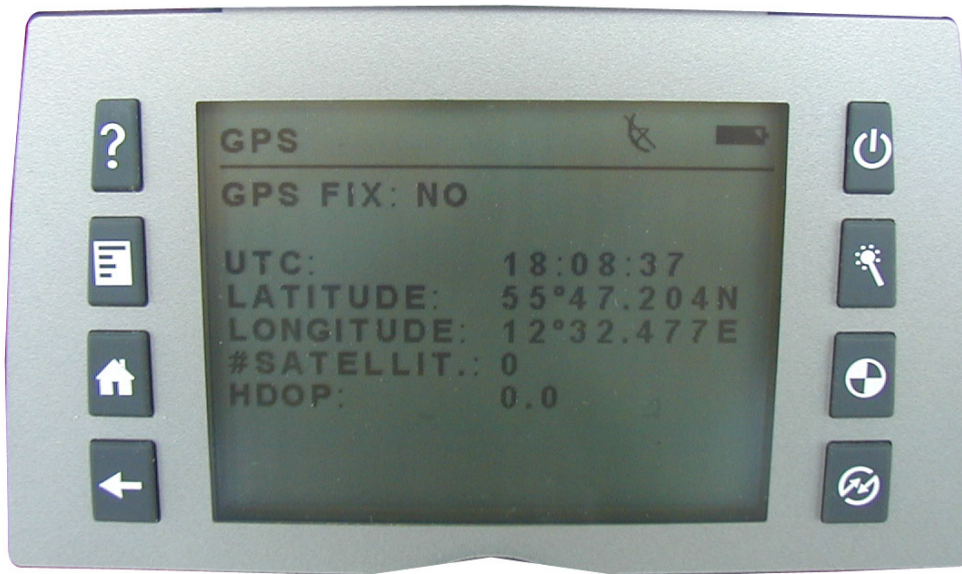

The GPS receiver is mounted inside the instrument and is supplied by the internal battery. It is used to supply positional data (latitude and longitude) to the log together with the measurement data. If enabled, a GPS icon is shown in the upper icon row.

Global Positioning System

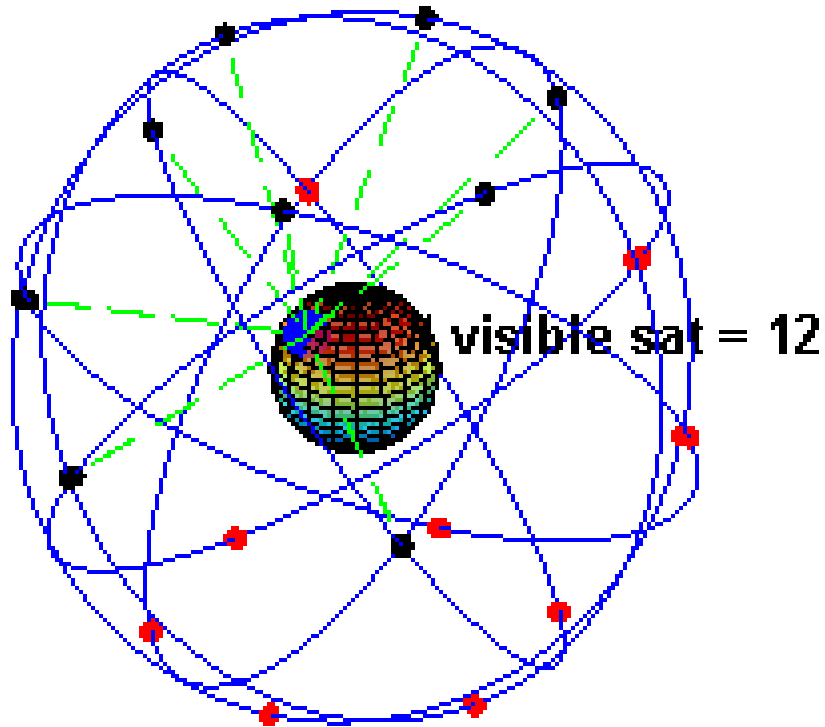

GPS uses a constellation of 24 to 32 satellites that transmit precise signals, that enable GPS receivers to determine their location, speed, direction, and time

Series ID Screen



Series ID's can be activated

- Enter new ID
- Edit preset ID's
- Delete preset ID's
- The User can preset up to 250 ID's
- Preset 6 road marking icon for each Series ID

Icon Preset Display



The LTL-X comes with 24 Icons of which 6 can be preset to display on the last line of the display.

Log Screen



This menu gives you the ability to:

- Clear Data
- View Log
- Status (of the log)
- Type (of storing data)

Log Screen (continued)



The data log can store up to 1500 measurements.

Information stored in the Log:

- Measurement data
- Date & Time
- Series ID
- Road marking icon
- User ID
- GPS data

View entire log on screen

Status Screen



Average



The Average function can be activated showing the average of the measured R_L value calculated over a selectable number of measurements (2 to 99). The average mode can be **fixed** or **moving**.

Average



The Average function can be activated showing the average of the measured R_L value calculated over a selectable number of measurements (2 to 99). The average mode can be **fixed** or **moving**.

Battery Status





Help System



Press the HELP button to show the help page for the current function. Pressing HELP once more will present a general help menu in which you can highlight a subject by using the UP or DOWN button and then pressing the OK button to show the help text.

Errors and Warnings

When a measurement is taken, a status number is generated and saved in the log together with the measurement. The status number reflects various conditions concerning the measurement. If a certain problem has arisen, a warning icon  or an error icon  is shown above the measure display and an audible alarm is sounded (if enabled).

When to calibrate

- Before the start of work each day at the work site
- If the LTL-X has not been used for 30 minutes or more
- Once every 2 hours if the LTL-X is being used continuously all day
- Calibrate the LTL in the field using the **Red Field Block**
- Keep the traceable calibration block (**Black Block**) at the office

Calibration Block Position for Calibrating

Figure A:
Zero Calibration Position



Figure B:
Reference Calibration Position



During the calibration procedure

- The LTL-X handle should be in the down position
- The wheels should not be installed
- The LTL-X should be on a flat surface

“Office” Calibration Procedure (Prior to Field Use)

Black calibration block

1. Press the calibration button.
2. Put the black block underneath the unit with the light trap (dark side) facing in. Align pins to fit.
3. Press the **green** button to start “zero calibration”.
4. The number on the screen should match the number determined by the lab and located in the black box.
5. If the number is different, select the up or down arrows to correct it to the predetermined lab number.
6. Turn the black block around with the white ceramic facing in.
7. Press the green button.
8. Select Print and then Home.



continues

“Office” Calibration Procedure (Prior to Field Use)

Red calibration block

1. Put the **red** block underneath the unit with the white ceramic facing in; align the pins.
2. Press the **green** button for the “reference” calibration.
3. Write the number and date on the small slip of paper and insert it in the **red** block which will go out in the field with the retroreflectometer.



“Field” Calibration Transfer (Prior to First Measurement)

Red calibration block

1. Press the calibration button.
2. Put the **red** block underneath the unit with the light trap (dark side) facing in.
3. Press the **green** button.
4. The number on the screen should match the number determined earlier at the office and documented on the slip of paper in the **red** block
5. If the number is different, select the up or down arrows to correct it to the predetermined number on the slip of paper.
6. Turn the **red** block around with the white ceramic facing in
7. Press the **green** button
8. Select Print and then Home



Procedure for Taking Measurements

- Place the LTL-X on the marking straight down making sure that the LTL-X covers the marking as much as possible
- Moving the LTL-X is done by lifting the unit straight up and moving it to the next position to take a reading. Do not slide unit, this can cause damage to the optic window
- Press the Operate (Green) button to take a reading



Handle Extension

Extension
Red Button



The operating panel can be adjusted in height for ergonomic considerations. The height is adjusted by pressing the red button on the front of the instrument and at the same time lifting the handle on the operating panel. Release the button and continue lifting until the handle locks.

Cleaning the LTL-X



- **Do not clean the Black Office Block**
It is your traceable standard. It can only be certified by Delta Light & Optics.
- Clean the **Red Field Block** with Windex & a lint free cloth. After cleaning a **calibration transfer** needs to be performed.
- Clean the optic window with Windex & a lint free cloth.

Built-in Printer

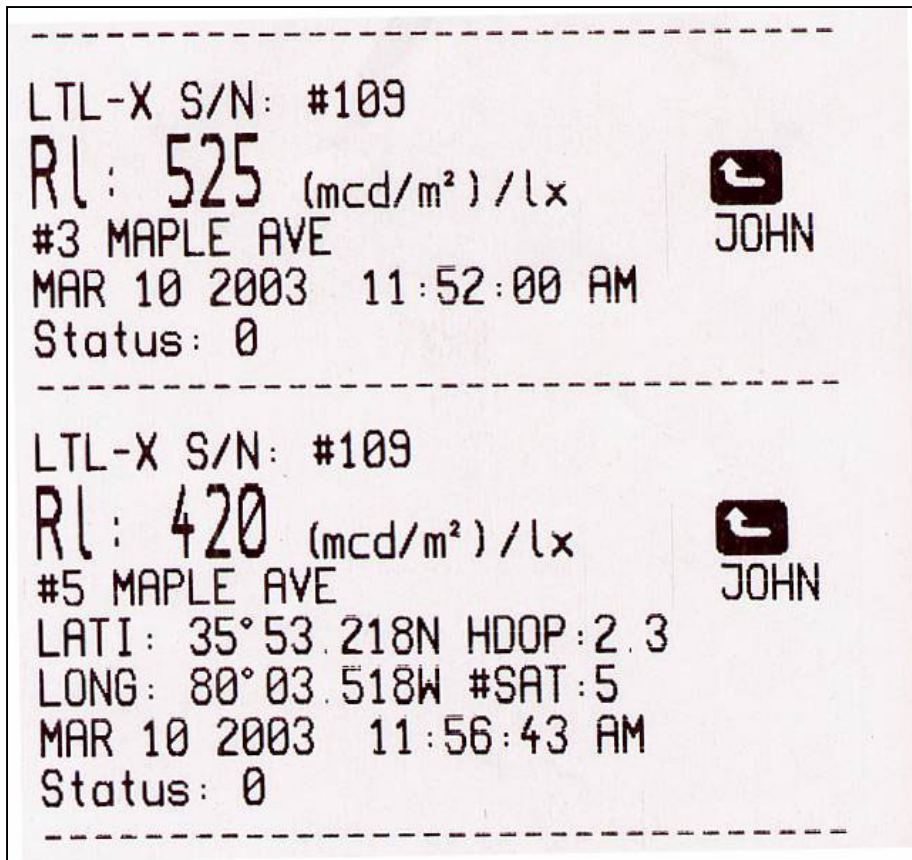

Communication with the LTL-X

The LTL-X downloads its data to a computer by means of the RSC program.
(Road Sensor Control)

- Projects Developed
- User Settings
- Log Download

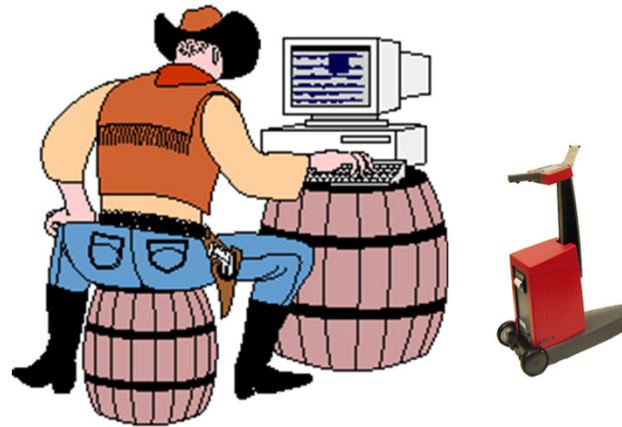

Lets Communicate

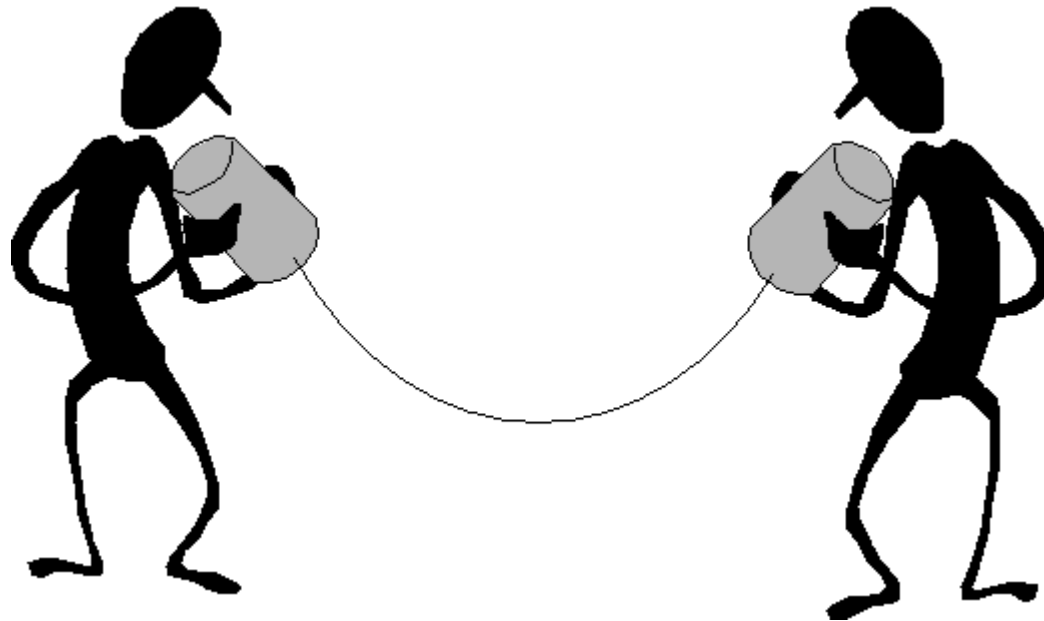

Shall We

Annual Maintenance



Through Ennis-Flint Annual Maintenance Program, a factory trained and authorized personnel will thoroughly check, adjust and/or repair your instrument if it fails to meet the high quality standards set by DELTA during the original manufacture.

LTL-X MANUAL

LTL-X RETROMETER

Manual

On site quality control of road markings & road surfaces in accordance with CEN / ASTM specifications



DISCLAIMER

The information contained in this document is subject to change without notice.

DELTA LIGHT & OPTICS MAKES NO WARRANTY OF ANY KIND WITH REGARD TO THIS MATERIAL, INCLUDING, BUT NOT LIMITED TO, THE IMPLIED WARRANTIES OF MERCHANTABILITY AND FITNESS FOR A PARTICULAR PURPOSE. DELTA LIGHT & OPTICS SHALL NOT BE LIABLE FOR ERRORS CONTAINED HEREIN OR FOR INCIDENTAL OR CONSEQUENTIAL DAMAGES IN CONNECTION WITH THE FURNISHING, PERFORMANCE OR USE OF THIS MATERIAL.

Caution: Changes / modifications not approved by the responsible party could void the user's authority to operate the equipment.

NOTE: This equipment has been tested and found to comply with the limits for a Class A digital device, pursuant to part 15 of the FCC Rules. These limits are designed to provide reasonable protection against harmful interference when the equipment is operated in a commercial environment. This equipment generates, uses, and can radiate radio frequency energy and, if not installed and used in accordance with the instruction manual, may cause harmful interference to radio communications. Operation of this equipment in a residential area is likely to cause harmful interference in which case the user will be required to correct the interference at his own expense.

Rev. 15 August 2012
SW ver: (MMC V3.04 up)



R&TTE Declaration of Conformity (DoC)

Unique identification of this DoC: 80_LTL-X EU_DoC 001

We,

DELTA Dansk Elektronik, Lys & Akustik
Venlighedsvej 4, Hørsholm
DK-2970 Hørsholm

declare under our sole responsibility that the product:

Product name: LTL-X Retrometer
Trade name: DELTA LTL-X
Type or model: All types pursuant to the referenced trade name

to which this declaration relates is in conformity with the essential requirements and other relevant requirements of the R&TTE Directive (1999/5/EC).

The product is in conformity with the following standards:

HEALTH & SAFETY (Art. 3(1)(a)):
EN 60950-1:2006 + A11:2009 + A1:2010 + A12:2011
EMC (Art. 3(1)(b)):
EN 301489-1 V1.8.1:2008
EN 301489-3 V1.4.1:2002
SPECTRUM (Art. 3(2)):
EN 300440-2 V1.4.1:2010

Supplementary information:

The equipment incorporates a GPS module.
The equipment is Class 1 radio equipment which can be placed on the market and be put into service without restrictions.

Technical file held by the undersigned.

Place and date of issue (of this DoC): July 1st 2012

Signed by or for the manufacturer:



(Signature of authorized person)

Name (in print):
Pernille Veje
Vice President QA/RA & E



US Attestation of Conformity (AoC)

Unique identification of this AoC: 80_LTL-X_US_AoC 001

We,

DELTA Dansk Elektronik, Lys & Akustik
Venlighedsvej 4, Hørsholm
DK-2970 Hørsholm

declare under our sole responsibility that the product:

Product name: LTL-X Retrometer
Trade name: DELTA LTL-X
Type or model: All types pursuant to the referenced trade name

to which this attestation relates is in conformity with the essential requirements and other relevant requirements of 47 CFR FCC Part 15.

The product is exempted from other specific FCC rule parts than the general rule parts 15.5 and 15.29 pursuant to specific rule part 15.103(c), as it is intended solely for use as industrial test equipment. However, the product is verified according to the specific rule parts:

47 CFR Part 15B, subpart 15.107 (Class A)
47 CFR Part 15B, subpart 15.109 (Class A)

The equipment is safety tested with CB Scheme certification under the internationally harmonized safety standard:

IEC 60950-1:2005 (2nd Edition); Am 1:2009

Supplementary information:

The equipment incorporates a GPS module.

Technical file held by the undersigned.

Place and date of issue (of this AoC): July 1st 2012

Signed by or for the manufacturer:

.....
(Signature of authorized person)

Name (in print):
Pernille Veje
Vice President QA/RA & E

NOTE: This equipment has been tested and found to comply with the limits for a Class A digital device, pursuant to part 15 of the FCC Rules. These limits are designed to provide reasonable protection against harmful interference when the equipment is operated in a commercial environment. This equipment generates, uses, and can radiate radio frequency energy and, if not installed and used in accordance with the instruction manual, may cause harmful interference to radio communications. Operation of this equipment in a residential area is likely to cause harmful interference in which case the user will be required to correct the interference at his own expense.

TABLE OF CONTENTS

SECTION 1	7
OPERATING INFORMATION	7
LTL-X introduction	7
LTL-X retrometer features.....	8
Options.....	8
Getting started.....	9
Important guide lines for the correct use of the LTL-X.....	12
SECTION 2	14
GENERAL INFORMATION	14
The measurement	14
Optical principle	15
Notes on error sources	16
High temperature conditions.....	16
SECTION 3	17
THE USER INTERFACE	17
Display and keyboard layout	17
Measurement display	17
Upper icon row	17
Lower icon row.....	18
Pushbuttons.....	18
The menu tree	20
SETTING UP FOR MEASUREMENTS	21
Selecting a user ID.....	21
Selecting a road marking icon.....	22
Setting the date and time.....	23
Setting the display, contrast and back light.....	25
Setting the sound level.....	25
Setting the language.....	25
Setting the SMART key function	25
Setting the aux functions.....	26
Setup	28
Auto off.....	29
Series id	30
Working with series ID (name).....	30
Activate.....	30
Selecting a series ID	30
Enter a new series ID	30
Removing a series ID.....	31
Setting the road marking icon	31
The log	33
Clearing data in the log	33
Amending clear data.	33
Viewing the log.....	34
View series data.....	35
Log status.....	35
Setting the log type	36
Other settings	37
Average function	37
Editing names	38
Diagnosis	39
Choosing output device	39
The help system	39
Errors and warnings.....	39

Default settings / user reset	40
RSC program	40
SECTION 4.....	41
MAINTENANCE.....	41
General care	41
Protection window	41
Battery	41
Fuses	43
Lamp	43
Calibration unit	44
Calibration	45
Printer	47
Mounting the wet night rails for rain measurements	48
Mounting the wheel unit (option)	50
APPENDIX A.....	51
COMMUNICATION FACILITIES.....	51
Communication specification	51
APPENDIX B.....	52
SPECIFICATION.....	52
General characteristics	52
Electrical characteristics	Error! Bookmark not defined.
Environmental characteristics	53
Mechanical characteristics	53
APPENDIX C.....	54
DELIVERY	54

SECTION 1

OPERATING INFORMATION

LTL-X introduction

The LTL-X retroreflectometer is a portable field instrument intended for measuring the retroreflection properties of road markings in car headlight illumination, the value R_L (coefficient of retroreflected luminance) is used. R_L is a measure of the lightness of the road marking as seen by drivers of motorized vehicles in car headlight illumination. The road is illuminated at an angle of 1.24° and the reflected light is measured at an angle of 2.29° , which corresponds, to an observation distance of 30 meters. This is relevant for a motorist's viewing situation under normal conditions.

R_L is an important factor in the **ON-SITE** quality control of road markings.



The operation of the retrometer is very simple and requires minimal instruction.

The LTL-X measures the retroreflectivity and calculates R_L according to international agreements. Results are presented in plain text on a large graphic display. Error messages or warnings are shown in the display in case of any problems during use.

The built-in printer and memory provides registration of measurements with corresponding date and time and other important data. The following data is also registered (if enabled):

- Name of measuring series (road name).
- Profile (icon) for road marking.
- User initials.
- GPS data (if installed).

Communication with a PC using the RSC-program (see pg. 40) allows for data exchange with other PC programs, extended command, calibration, diagnostics and other facilities.

A rechargeable NiMH battery powers the LTL-X, giving hours of measurement capacity. A mains powered battery charger power supply is supplied as standard. The instrument can also be charged from a 12-18V source such as a car battery using an adapter.

LTL-X retroreflectometer features

- Portable self-contained instrument
- Small dimensions / low weight
- Ergonomic operation height
- Fast measurement (completed in less than 1 sec)
- Measuring on dry and wet surfaces (or the continuous wetting measurement method)
- Will measure flat, textured & profiled markings
- Built-in thermal printer
- Fully documented measurements with automatic data storage, user and series identification for labeling and grouping measurements
- Audible signals during use
- RSC PC software for data exchange, extended control, etc. Log data can be exported to applications such as Microsoft Excel
- Easy calibration procedure
- Traceable and accredited calibrated reflection standard
- User replaceable battery
- Fast charging (approx. 1 hour)
- Rechargeable from power adapter or a car battery using an adapter
- Average (2-25 readings)
- Multiple languages
- Wheel unit

Options

- GPS, for precise logging of measuring location
- Large battery pack with more capacity for extended use between charges

Getting started

Buttons:

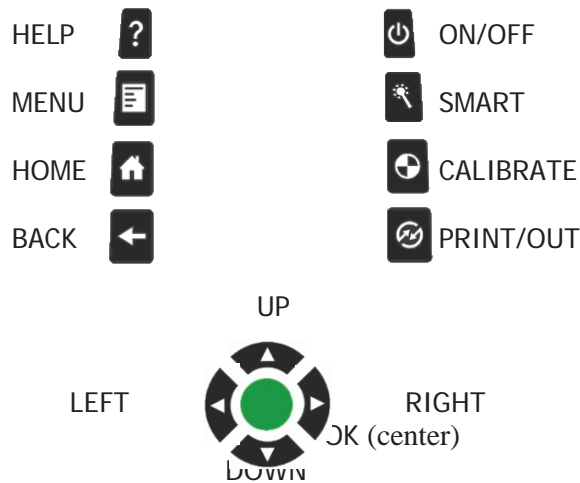



Figure 1. Buttons

Height adjustment

Before using the LTL-X, notice that the operating panel can be adjusted in height for ergonomic considerations. The height is adjusted by pressing the red knob on the front of the instrument and at the same time lifting the handle on the operating panel. Release the knob and continue lifting until the handle locks.

Measuring

Turn on the LTL-X by pressing and holding the ON/OFF button  until the welcome message appears. The display will then change to the measure mode. (An exception is when the instrument is set to ask for user identification, see **User select** in this section).

Calibrate the instrument if necessary. See **Calibration** in this section.

Place the instrument on the road marking.

Press the green OK-button  to take a measurement. A measurement will be finished in approx. 1 sec.

When the measurement is complete, the R_L value will be displayed. Data is automatically transferred to the data log. If there is a problem with the measurement a warning icon or an error icon will pop up (see **Warnings and errors**, see **pg. 39**) and an audible alarm will sound (if enabled, see **Sound settings**).

Measurements taken with a battery voltage that is too low are rejected or marked in the log and an error icon appears.

To print the last measurement data, press the PRINT/OUT button . The Print/Output function must be set to **Int.** (See **pg. 39**). Printing can be stopped by pressing the PRINT/OUT button or the ON/OFF button for approximately 0.5 sec.

User select (user initials)

If a user icon  is displayed in the upper icon row on the measuring display, press the UP button ▲ and if necessary ◀ or ▶ to mark the user icon. Press the OK button to enter the user select menu. For further information see **Selecting a user id, pg. 21**

Series ID select (name)

From the HOME screen (measure display) press the UP button ▲ to mark the road icon . Press the OK button to enter the series ID select menu. Select a name from the list using UP or DOWN and accept with OK.

Calibration

The instrument is supplied with two calibration units, a reference calibration unit (black) and a field calibration unit (red). The reference calibration unit is factory calibrated and traceable to PTB. The field calibration unit must be calibrated against the reference calibration unit by the user at suitable intervals. The reference calibration unit is stored in the black protection box, and the field calibration unit in the grey protection box.

Two steps are required for a complete calibration, *zero calibration* and *reference calibration*. The instrument will guide you through the procedure.

Calibration procedure

• Zero calibration

Press the CALIBRATION button  once. Mount the calibration unit underneath the front end of the instrument by tilting the instrument slightly backward. Make sure that the end pins on the side of the calibration unit fit into the slots in the LTL-X.

It is important that the calibration unit faces with the dark opening toward the instrument tower. The display will show the correct orientation of the calibration unit. Make sure that the calibration unit and the light trap is clean. Press the OK button to start *zero calibration* (*black calibration*). During calibration the lamp will flash a number of times.

• Reference calibration

After zero calibration, the instrument is ready for the reference calibration (white calibration). The display will tell you to turn the calibration unit so that the white face is facing the instrument tower. Again, it is important that the pins on the side of the unit fit into the slots in the LTL-X. Press the OK button to start reference calibration. Check the value displayed, and if necessary, adjust the calibration value shown in the display so it matches the value stamped on the calibration unit.

Press the OK button to perform the calibration.

The calibration procedure is now complete. Remove the calibration unit and store it properly. Press OK to return to the measurement display. For further details see **pg. 45**.

Control Calibration.

Use in case of doubt during on site measurement. Follow the traceable calibration procedure using the red control calibration unit. Use the RI value from the control calibration unit label.

Transfer of calibration value.

At regular intervals the traceable calibration value must be transferred from the reference calibration unit to the control calibration unit.

Mount the reference calibration unit and perform a complete traceable calibration. Replace the reference calibration unit with the control calibration unit and make a normal R_L measurement. Label the Control Calibration unit with the value and the date.

Warnings and errors

An error or warning icon will appear in the upper row of the display if the LTL-X detects a problem. Press the UP button ▲ to get a description of the most serious error or warning. Now press the OK button to display a total list of all errors or warnings related to the measurement.

Sound setting

Press the MENU button  and select **SETTINGS / SOUND**. Select **KEY CLICK** or **SOUNDS** to set the individual sound levels for key click and warning/error sounds. Use the UP ▲ or DOWN ▼ button to set the level. Accept the setting by pressing the OK button. A loud additional beep can be selected by pressing the OK button when **BEEP** is highlighted.

Miscellaneous

The HOME screen can be activated at any time by pressing the HOME button .

Reset log: Press the MENU button  and select **LOG / CLEAR DATA**. Now select from the menu: **LAST**, **ALL** or **SERIES**.

Date and time: Press the MENU button and select **SETTINGS / DATE & TIME**. Use the UP ▲ and DOWN ▼ buttons to set the time and date. Accept the setting by pressing the OK button.

Power save: Press the MENU button and select **SETTINGS / AUTO OFF**. Use ▲ and ▼ to edit the auto turn off time.

Data exchange / communication

The RSC program, developed by DELTA for use on a PC, allows data to be exchanged between the LTL-X and a PC. See **RSC-program, pg. 40**.

Important guide lines for the correct use of the LTL-X

Positioning of the instrument on the road marking

Select an area of the pavement marking that is level when taking readings. The red dot on the side of the base cover indicates the center of the measurement field on flat markings. The measurement field is approx. 45 mm wide and 200 mm long. Ensure the pavement marking to be measured is free of debris before taking measurements. Make sure that the instrument is stable positioned.

Reason: The LTL-X has three support pads, each with a small footprint. An uneven marking or a small piece of gravel trapped under one of the pads will move the measurement field and affect the reading.

Taking the measurement

Press the green OK button to take a single reading. Do not put pressure on the handle when taking a measurement.

Reason: Pressure on the handle can affect the measurement geometry and thus influence the reading.

Number of measurements.

For accurate readings, do not take just one reading of a road marking. Three readings will give a more accurate result than one reading. Five readings will give a more accurate result than three readings, etc. Take the readings in adjacent areas of the marking. Let the instrument calculate the average of the readings (fixed or moving average options).

Reason: A road markings retroreflectivity varies from area to area. It is not unusual to see variations of 5% - 20% when the instrument is moved even less than 10 mm/ 1/2" in either direction.

Obstructions in front of the LTL-X

Ensure the pavement marking to be measured is clear of any obstructions at least 1 meter/ 40 inches in front of the LTL-X. For example, do not stand in front of the instrument when taking the reading, and do not have anyone else standing in front of the instrument while taking the reading.

Reason: The observation field of the LTL-X extends beyond the front opening of the instrument.

RPM's/retroreflective materials in front of the LTL-X

Recommended Procedure: Ensure there are no retroreflective materials not belonging to the marking at least 1 meter / 40 inches in front of the LTL-X. For wet road markings this distance is 2 meters/ 80 inches. Examples of such materials are raised pavement markers, high visibility clothing and shoes with retroreflective properties. Whenever the user suspects that materials ahead affect the reading the material should be covered with a dark cloth.

Reason: The observation field of the LTL-X extends beyond the front opening of the instrument, and such retroreflective materials can cause false readings.

Protection of the display/display shield.

For the protection of the display and longevity of the instruments keep the display shield closed when the instrument is not used. For further information please see section 2.

**FOR THE PROTECTION OF
THE DISPLAY AND LONGEVITY
OF THE INSTRUMENT, KEEP
THE SHIELD CLOSED WHEN
THE LTL-X IS NOT IN USE**



Remember:

- LTL-X is an optical precision instrument, handle with care.
- Keep the protection window and calibration unit clean.
- Store in a clean and dry environment.

SECTION 2

GENERAL INFORMATION

The measurement

The LTL-X retroreflectometer measures the R_L (coefficient of retroreflected luminance) parameter. The R_L parameter represents the brightness of road markings seen by drivers of motor vehicles by headlight illumination.

In the LTL-X the illumination angle is 1.24 degrees and the observation angle is 2.29 degrees. According to both ASTM and CEN standards this angle simulates a driver's viewing distance of 30 meters. The instrument's illumination field is approximately 200 mm x 45 mm and the observation field is approximately 610 mm x 60 mm. The dimensions are given for plane surfaces. **For real non-planar road markings the fields are elongated.** The measurement field is identical with the illumination field.

The figure below shows the placement of the fields for normal and continuous wetting operations. For continuous wetting measurements the instrument is raised 7 mm by mounting the wet night rails (See pg 48).

In this operation the illumination/measurement field is placed just in front of the horizontal base cover allowing the continuous wetting.

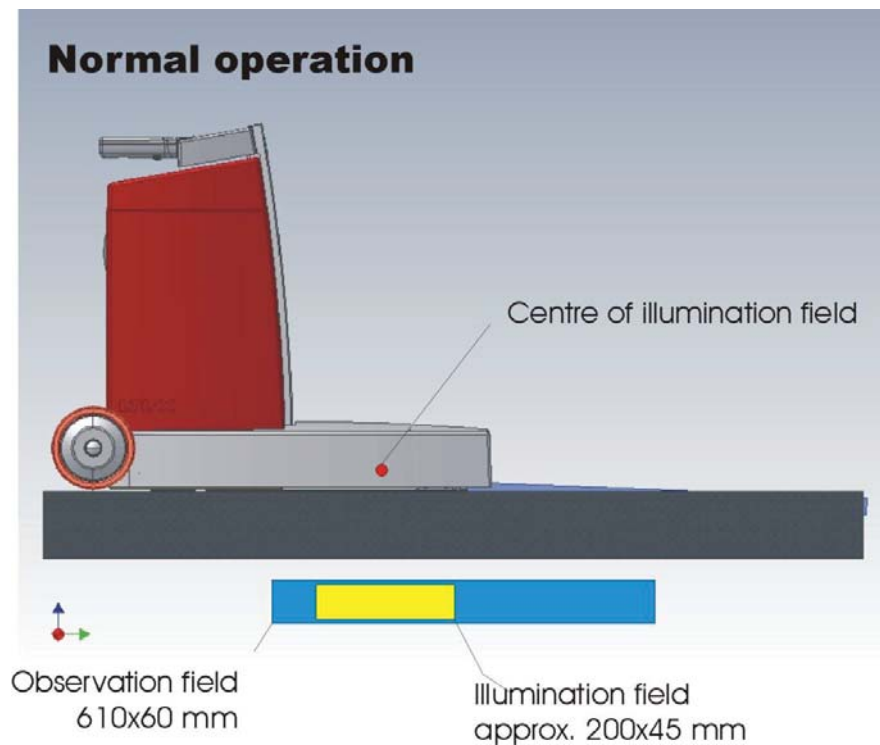

Figure: 2 – Measurement field

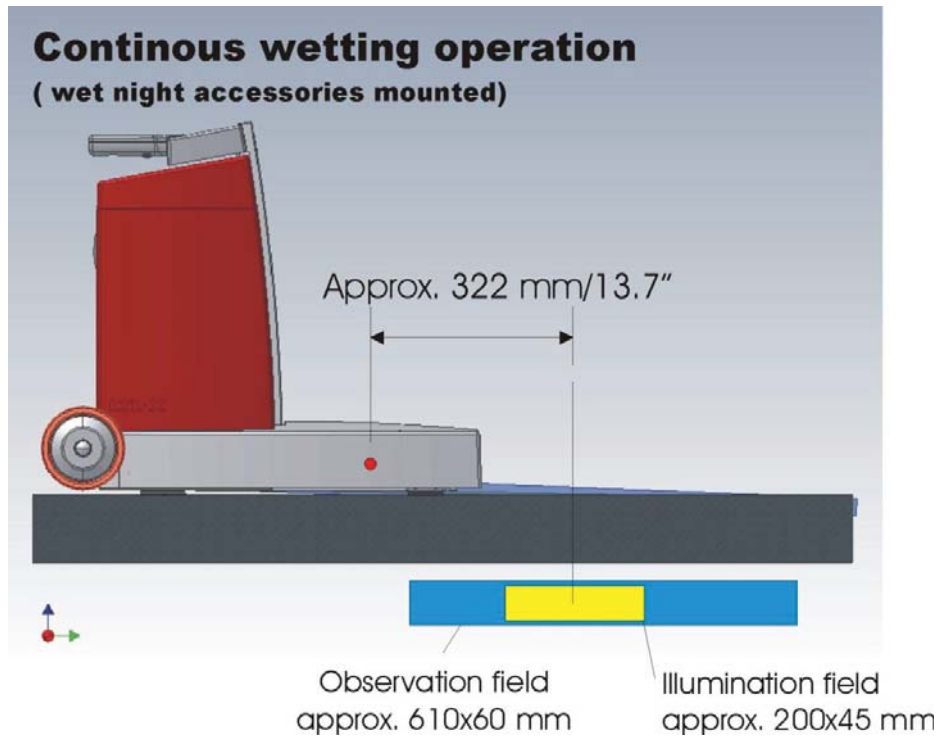

Figure: 3. Measurement field with wet night accessories mounted.

The tower of the LTL-X contains the illuminating and observation system and the control electronics. At the bottom of the tower an optical system, with mirror, directs a beam of light toward the road surface through a dust-protection window. A polymer shielding covers the measuring area for normal operation (see above).

The LTL-X is controlled by multiple microprocessors. It is operated with an extractable keyboard located at the top of the retrometer. It executes the measurement automatically by push of a button and presents the result on a display. The result is automatically transferred to the internal memory. The measurement, along with its corresponding time, date, and other data can be printed using the built-in printer.

Optical principle

The optical system in the LTL-X is covered by a patent pending. A long life xenon lamp in the top of the tower generates the light for the measurements. After a field stop the light is collimated by a lens and deflected through a mirror toward the road.

The reflected light from the road uses the same mirror and lens. Between the lens and the photo detector field aperture, stops define the observation area. The illumination field is inside in the observation field. This is important to assure correct measurement on profiled markings.

V_{λ} spectral correction is achieved by use of advanced optical filters.

Notes on error sources

Stray light can occasionally enter the instrument but will be insignificant under normal measurement conditions. Before each measurement, the LTL-X automatically evaluates the leakage and compensates for it before the readout. In case of a significant leakage level, a warning or error message is given and special precautions may be necessary.

Instrument leak, drift and offset errors are compensated by means of data obtained during the calibration procedure. It is very important to keep the light trap, the dust-protection window and the ceramic on the calibration unit clean.

The LTL-X illumination angle is 1.24° relative to the road surface. Because of this small angle accurate placement on the road is important. Avoid pebbles and abnormal irregularities. The LTL-X must be parallel and in contact with the marking surface.

The LTL-X retrometer is a rugged instrument, but it is an optical instrument and must be handled as such.

The LTL-X is factory calibrated. Nevertheless start measurements with a calibration. Study the display for any warning or error icons. See also **Section 4 - Maintenance**

Note

Keep the light trap, dust-protection window and ceramics on the calibration unit clean.

Keep the battery fully charged. A well charged battery is more resistant to aging and damage.

High temperature conditions.

Display

If the display is exposed to intense direct sunlight during a longer period of time the display could become overheated.

To reduce heat an IR-reflecting filter is mounted on the display. It is recommended to close the protective display shield. The shield also protects against damages and scratches.

"Daylight readable" displays are vulnerable to high temperatures. High temperature will decrease the display service life.

When the display temperature exceeds 50°C / 122°F an audible alarm will sound. The alarm will sound for 20 second and then pauses for one minute. This sequence continues until the temperature is lowered or the instrument is turned off. The alarm can be suspended for one minute by pressing any key.

Battery

The battery is rated to maximum 45°C / 113°F operating temperature.

SECTION 3

THE USER INTERFACE

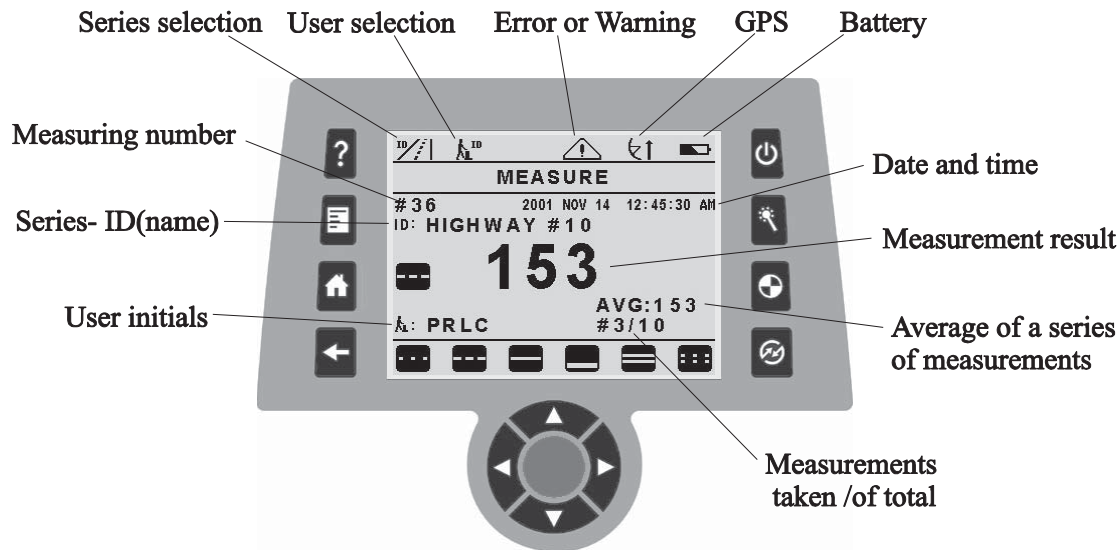

Figure: 4 – Display

Display and keyboard layout

The user interface consists of a rectangular display surrounded by push buttons.

The display has two main modes: the *measurement display* (HOME screen) and the *menu display*.

The instrument will start up with the measurement display shown. The display area is divided into four areas: a large main display in the middle, an icon row at the top, a message or caption field underneath and an icon row at the bottom.

Measurement display

Here the last measured RI value is presented with large digits together with other information. On the graphic above, all possible information is shown in the display. If a function is deactivated, it will not be shown. The actual date and time is always shown.

Upper icon row

The upper row of icons is accessed by pressing the UP button ▲. One of the icons is then highlighted (inverted) and can then be activated by pressing the OK button. The other icons in the row can be accessed by using the LEFT ◀ or RIGHT ▶ buttons. The meanings of the icons are (from left to right):

- Series ID (name) selection.
- User ID (initials) selection. Can be switched off (see [pg. 21](#)).
- Error/warning alarm. Will be shown in case of an error/warning (see [pg. 39](#)).
- GPS indication (see [pg. 26](#)).
- Battery status (see [pg. 43](#)).

Lower icon row

- From the lower icon row you can select a road marking icon that will be saved together with the measurement in the log (see **pg. 21**) for future measurement identification. Access the icons by pressing the DOWN button ▼. Use the LEFT or RIGHT button to mark the preferred icon. Pressing DOWN again shows more icon rows from a roll stack of four rows. One row, marked with a "PR" for "Preset" can be preset by the user (see **pg. 31**) and is saved separately for each measuring series. It will be the active icon row, ready for selection, when a measuring series is selected. The measuring schedule upload (see **pg. 40**) includes series ID and the six preset icons for each series.
- Activate the marked icon with the OK button or exit with the HOME  or UP ▲ button. The selected icon is now shown in the left side of the HOME screen and the instrument is again ready for measuring.
- Other functionality regarding the lower icon row:
Activating an already selected icon will cancel the activation and remove the icon from the main display (and no icon will be saved by the next measurement). When the measurement display is selected (with the MENU button or the BACK button) the lower icon row will be the same as when the measurement display was last shown. Pressing DOWN and then UP in the HOME screen will show the row with the currently selected icon marked.

Pushbuttons

OK 

When the message row shows MEASURE, press the OK button to take a measurement. In most other cases pressing the OK button will activate a highlighted selection.

ON/OFF 

Turn the instrument *ON* or *OFF*. Press the button to turn *ON* the instrument. To turn it *OFF* hold down the button for about half a second until the display shows a farewell message. When the instrument is on, a short press on the button will turn on the display backlight (if enabled, see **pg. 25**).

HOME 

Bring you back to the measurement display.

BACK 

Backward one step in the menu, canceling new settings which has not yet been confirmed by the OK button. In most cases the LEFT button has the same function.

HELP 

Present a context sensitive help text. Another press on the button will open up a general help menu.

Menu 

Selects the top level of the menu tree, the main menu. Use the UP and the DOWN buttons to scroll through the menu items. Press OK to select the highlighted item. In some cases it opens up future submenu levels.

SMART 

This button is user programmable to one out of several functions, e.g. to clear the last measurement, see **pg. 25**.

CALIBRATE 

Starts the calibration wizard, see **pg. 45**.

PRINT/OUT 

Print out the last measurement or selected parts of the log to the internal printer or send data to the communication port, see **pg. 39**.

The menu tree

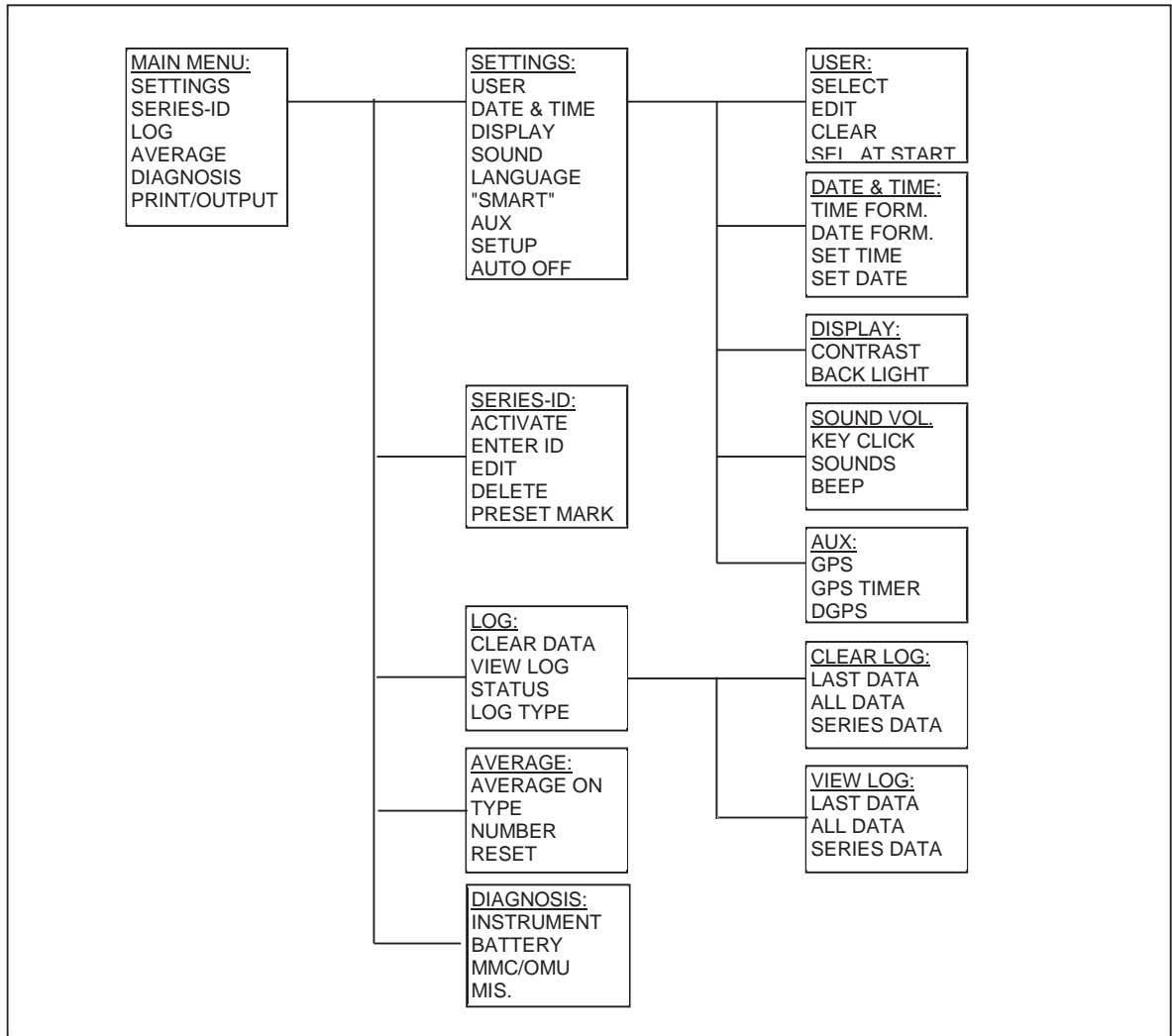

Figure: 5 – Menu tree

SETTING UP FOR MEASUREMENTS

Selecting a user ID

The user ID (user profile) is used to identify the operator and is saved in the log together with each measurement. It consists of up to four characters, for instance initials of the operator's name. If enabled, it can be seen at the lower left side of the measurement display. Measurements can also be taken without a user ID.

Eight user ID's can be stored in the instrument.

Certain instrument settings are stored individually for each user. Selecting a user will restore these settings.

Following settings are stored:

- All sound settings
- SMART key
- Back light timer
- Instrument auto off timer
- Advanced / basic menu setup

The select procedure.

1. *If a user select icon  is not seen in the upper icon row:*
Press the MENU button and select **SETTINGS / USER / SELECT** to display the **SELECT USER** menu.
2. *If a user select icon is seen in the upper icon row:*
Press the UP button. Then, if necessary use the LEFT or RIGHT button to highlight the user icon. Press the OK button. The **SELECT USER** menu is shown:

SELECT USER:	▲▼OK
Off	
KFP	
HEN	
JOHN	
U4	
U5	
U6	
U7	
U8	

Now use the UP or DOWN button to highlight a user name.

Press the OK button to accept the name.

In case 1 press the HOME button to return to the HOME screen.

In case 2 the apparatus will automatically return to the HOME screen.

Changes made to the above mentioned individual instrument settings are automatically stored in the selected user ID.

User names can be edited from the menu **SETTINGS / USER / EDIT** (see editing pg. 38).

Selecting *OFF* will deactivate the user function and set all individual instrument settings to default.

Clear user

USER: HEN	▲▼OK
SELECT	
EDIT	
CLEAR	
SEL. AT START	NO

Clearing the user id will rename the user name to its default name (U1 to U8) and all individual instrument settings are set to default.

SELECT USER:	▲▼OK
Off	
KFP	
U2	
JOHN	
U4	
U5	
U6	
U7	
U8	

Select at start

USER: JOHN	▲▼OK
SELECT	
EDIT	
CLEAR	
SEL. AT START	YES

Enabling *SEL. AT START* will force the user to select a user ID each time the LTL-X is turned on. The last used user ID is automatically highlighted.

Press the MENU button and select SEL. AT START. Press OK to toggle between YES and NO

Selecting a road marking icon

The purpose of a road marking icon.

The road marking icons are used as labels for the individual measurement corresponding to the measured road marking and will be saved in the log together with the measuring result. The icon will then be presented together with the corresponding measurement when viewing the log (see pg. 34) or by using the RSC program (see pg. 40).

There are 24 icons to select from. Six of the icons can be programmed as individual presets for each series (see pg. 31) and will be ready for selection when a series is selected.

The procedure.

From the HOME screen press the DOWN button.

Then use the LEFT or RIGHT button to highlight the wanted icon. Pressing DOWN steps through and displays the four icon rows. Pressing UP will return to the HOME screen without selecting a new icon.

Pressing the OK button will activate the selected icon. The selected icon is now shown in the left side of the measuring field and the instrument is again ready for measuring.

Deactivating the profile icon.

Activating an already selected marking icon will cancel the activation and remove the icon from the main display.

Setting the date and time

Date and time is always shown in the display. Every measurement taken is marked with the date and time, so it is essential that the settings are correct.

Press the MENU button and select **SETTINGS / DATE & TIME**. Press OK and the time format sub menu is shown.

Setting the time format

DATE & TIME	▲▼OK
TIME FORM.:	12 HR
DATE FORM.:	Y/MMM/D
SET TIME:	02:34:56 PM
SET DATE:	2001 NOV 24

Press OK when **TIME FORM** is highlighted. The time format menu is shown.

TIME FORMAT:	▲▼OK
24 HR	
12 HR	

Highlight the preferred time format by using UP or DOWN. Press OK to accept.

Setting the date format

Use UP or DOWN until **DATE FORM** is highlighted. Press OK and the date format menu is shown.

DATE FORMAT:	▲▼OK
MMM/DD/YYYY	
MM/DD/YYYY	
DD/MMM/YYYY	
DD/MM/YYYY	
YYYY/MMM/DD	
YYYY/MM/DD	
YYYY/DD/MMM	
YYYY/DD/MM	

Highlight the preferred date format using UP or DOWN. Press OK to accept.

Setting the time

Use UP or DOWN until **SET TIME** is highlighted. Press OK and the time menu is shown.

DATE & TIME	▲▼OK
TIME FORM.:	12 HR
DATE FORM.:	Y/MMM/D
SET TIME:	02:34:56 PM
SET DATE:	2001 NOV 24

Now use UP or DOWN to set the hour. Press the RIGHT button to select the minutes and repeat the procedure for minutes and seconds. Press OK to accept the setting. Note: the time in this menu is not live, but it will synchronize the time shown in the HOME screen.

Setting the date

Use UP or DOWN until **SET DATE** is highlighted. Press OK and the date menu is shown. Now use the same procedure as for setting the time.

Note:

Settings are first valid when OK is pressed. Until then you can abandon your changes with BACK or HOME.

Setting the display, contrast and back light

The backlight time display shows how long the display backlight will be turned on. To turn on the light briefly, press .

DISPLAY :		▲▼OK
CONTRAST	5	
BACK LIGHT:	60s	

Press the MENU button and select **SETTINGS / DISPLAY**. Select **CONTRAST** and press the OK button. The figure will be highlighted

DISPLAY :		▲▼OK
CONTRAST	5	
BACK LIGHT:	60s	

Now use the UP or DOWN button to change the contrast. Accept by pressing the OK button or leave unchanged by pressing BACK, LEFT or HOME.

The **BACK LIGHT** time is changed in a similar way.

WARNING: Using the backlight will drain the battery faster!

Setting the sound level

Press the MENU button and select **SETTINGS / SOUND**. Select **KEY CLICK** or **SOUNDS** to set the individual sound levels for key click and warning and error sounds. Use the UP or DOWN button to set the level. Accept the setting by pressing the OK button or leave unchanged by pressing BACK, LEFT or HOME.

A loud additional beep can be selected by pressing the OK button when **BEEP** is highlighted. This beep will be heard when a measurement cycle is completed. It lets the user know that it is ok to lift the instrument and move it to a new location.

Setting the language

Press the MENU button and select **SETTINGS / LANGUAGE**. Use the UP or DOWN button to select a language. Accept by pressing the OK button or leave unchanged by pressing BACK or LEFT.

English can always be selected at power-up by pressing and holding the HELP key before ON is pressed. This will override any language selection.

Setting the SMART key function

This button is user programmable to one of several functions, e.g. to clear the last measurement

Press the MENU button and select **SETTINGS / SMART KEY:**

SMART KEY:	▲▼OK
SELECT SERIES	
CLEAR LAST MEAS.	
RESET AVERAGE	
SER. ID ON/OFF	

Use the UP or DOWN button to select the SMART key function. Accept by pressing the OK button.

The selected function is now accessed every time  is pressed

Setting the aux functions

The Aux function is used to control auxiliary built-in equipment, e.g. a GPS receiver.

AUX:	▲▼OK
GPS	ON
GPS TIMER	OFF
DGPS	WAAS

Using GPS (optional)

The GPS receiver is mounted inside the instrument, drawing its power from the internal battery. The GPS system is used to supply position data (latitude and longitude) to the log together with the measurement data.

If activated a GPS icon is shown in the upper icon row (see **picture pg. 17**). The icon will display the quality (reliability) of the GPS signal. If DGPS (Differential GPS) is selected, and a valid DGPS satellite is recognized, a "D" is added to the icon. This is illustrated in the FAIR reception icon below.

In order to minimize the time required to get a GPS position fix after the LTL-X has been turned on, a "GPS TIMER" can be activated. This timer will keep the GPS unit powered up for 30 minutes after the instrument has shut off. If the instrument is turned back on within 30 minutes, the GPS will acquire a valid fix quickly.

Below is an explanation of the GPS icon states.

GOOD:  The GPS HDOP (Horizontal Dilution Of Precision) value is below 5.

FAIR:  The GPS HDOP value is larger than 5, but the GPS can FIX.

NO:  The GPS cannot FIX (weak or no signal).

The GPS position data, HDOP value, and the number of satellites used in the position calculation are saved in the log together with the R_L data.

Activating the GPS

Press the MENU button and select **SETTINGS / AUX**, highlight the GPS line and press the OK button to toggle the GPS ON or OFF. Press the HOME button to return to the HOME screen.

The GPS data can be viewed from the HOME screen by pressing the UP button and then highlighting the GPS icon by using LEFT or RIGHT buttons. Press the OK button to display the GPS data. When the GPS data changes the display is updated.

If the GPS does not fix and a measurement is taken a warning menu appears. You will be presented with the following options:

- Measure anyway
- Skip measurement
- Turn off GPS

GPS delayed off timer

Press the MENU button and select **SETTINGS / AUX**, highlight GPS TIMER and press the OK button to toggle the timer ON or OFF. Press the HOME button to return to the HOME screen. If the timer is activated a message showing the delayed off time is shown in the display when the LTL-X is turned off.

DGPS (WAAS / EGNOS) – optional.

DGPS (Differential GPS) can improve the basic GPS accuracy. If DGPS is used, the GPS unit will receive correction data from the geostationary satellites such as WAAS, EGNOS and others. WAAS / EGNOS reception does not require additional receiving equipment.

Currently, WAAS satellite coverage is only available in North America. Even though GPS users outside North America can receive WAAS, the signal has not been corrected and thus would not improve the accuracy of the position data. In some regions in the northern parts of the continent, the position of the satellites over the equator can make it difficult to receive the signals when trees or mountains obstruct the view of the horizon.

EGNOS is the European counterpart of the WAAS satellite and the same limitations apply.

Press the MENU button and select **SETTINGS / AUX**, highlight DGPS and press the OK button and the DGPS sub menu is shown.

DGPS	▲▼OK
OFF	
WAAS	
EGNOS	
AUTO	

AUTO will automatically search for a DGPS satellite.

When DGPS correction is selected the data is not necessary corrected immediately, it can take time to receive and process the correction signal.

LTL-X will show if the correction data is used. The GPS icon in the upper row of the display will include a "D".

If the GPS icon is selected, a line in the GPS screen will show the DGPS system used. If no correction system is selected, "N/A" will be displayed.

The log data will also record the status of the correction system. When saving the log using the RSC2 program, the column "FIX" will show the value 2 if the DGPS correction was used.

It is not possible to see which correction system was used.

For further information about the GPS system and WAAS / EGNOS webpages can be found that describe the systems and how they function.

Map datum.

The default map datum system is WGS84. There are more than 200 different map datums that can be selected. The selected datum can be seen in the GPS menu.

The datum information is also stored in the log.

Warning: Selecting the wrong map datum can result in substantial position errors!

For further information on selecting the correct map datum system, please contact your local mapping software distributor.

Contact your local distributor for further information on changing the map datum in LTL-X.

More about the GPS

The GPS unit will typically acquire satellite signals and process a position fix in 5-40 seconds. If the GPS receiver has been turned off for a long period of time, the time to first fix will take longer.

The GPS engine used has a navigation performance of 2.5 m CEP¹⁾

The precision of the GPS receiver in the LTL-X is determined by many factors. A few are listed below:

- Signal obstruction. The GPS receiver requires a clear view of the sky. Trees, buildings and other environmental objects can affect the satellite signals.
- Satellite constellation and geometry.
- Multi path (reflection of signal from buildings etc.).

The HDOP (Horizontal Dilution of Precision) is a number that indicates the quality and precision of the received GPS data (low values are better than high).

When the GPS is used, the operating time for the LTL-X will be decreased and you must charge the battery more often.

¹⁾ CEP (Circular Error Probable):

A statistical measure of the horizontal precision. The CEP value is defined as a circle's radius, when centered at the true position, encloses 50% of the data points in a horizontal scatter plot. Thus, half the data points are within a 2-D CEP circle and half are outside the circle.

Setup

Setup is used to separate between advanced or basic users. The basic settings reduce the number of menus available to the user. For example, in basic menu operation, users cannot clear the log.

The following menu points can be selected in basic mode:

Settings: user, date & time, display, sound, setup.

Log: status.

Diagnosis.

Print/output.

To change the setup, press MENU and select **SETTINGS / SETUP**. Pressing OK will toggle between *ADVANCED* and *BASIC*.

To return from setup press BACK, LEFT or HOME.

Auto off

To save power, the instrument can be programmed to automatically shut off if not used.

When communicating with RSC program the instrument will not power down automatically.

Press the MENU button and select **SETTINGS / AUTO OFF**. Use UP and DOWN to edit the auto turn off time.

The off time can be set from 60-300 sec. in intervals of 60 sec. or it can be deactivated (*OFF*)

SERIES ID

Working with series ID (name)

The purpose of a series ID.

The series ID is a label. For example, it could be the name of the road.

Although measurements can be performed without selecting a series ID, it is convenient to group (name) the measurements for each geographical spot, road or part of a road for easier recognition of each measurement.

The series ID for such a group of measurements will be saved in the log together with the measuring results. The ID must be selected prior to the measurement.

The individual measurements in a group can further be labeled by selecting a road marking icon (see pg. 31) corresponding to the actual road. Measurements taken with the same series ID are automatically marked with a unique number.

The instrument can store 250 series ID's.

The series ID can be entered manually but it is far more convenient to enter the series ID's in the RSC program (see pg. 40) and transfer them to LTL-X.

Activate

To use the series ID it must be activated. Press the MENU button and select: **SERIES ID / ACTIVATE**. By pressing OK you can toggle between *ON* and *OFF*, to activate or deactivate the series ID function. Press the HOME button to return to the HOME screen. When the series ID is off no ID is shown in the display and ID's in the log marked: "No name".

Selecting a series ID

From the HOME screen press UP. If necessary, use the LEFT or RIGHT button to highlight the road icon . Press the OK button. The **SELECT SERIES** menu is shown:

SELECT SERIES:	▲▼OK
NEW	
ROAD #2	
HIGHWAY #1	
HIGHWAY #2	
HIGHWAY #3	

Now use the UP or DOWN button to highlight a series name. If the symbol ">" is displayed in the top right corner then more series can be accessed by pressing the RIGHT button. Press the OK button to accept the name. The instrument will now return to the HOME screen.

Enter a new series ID

Do the same as above but select **NEW** from the series list (or select **MENU / SERIES ID /**

ENTER ID). Proceed by spelling the series name (see **Editing pg. 38**).

Removing a series ID

This will remove the series ID from the selection list.
Press the MENU button and select **SERIES-ID / DELETE**:

DELETE SERIES-ID ▲▼OK
ROAD #1
ROAD #2
HIGHWAY #1
HIGHWAY #2
HIGHWAY #3
1 11 04 2001 - 11 04 2001

Use UP or DOWN to select the series that should be deleted. Accept by pressing the OK button. A confirm menu is shown:

DELETE SERIES? ▲▼
NO
YES, ALSO IN LOG

Select with UP or DOWN and accept with OK.

Note! All measurements in the selected series will be erased from the log!

Setting the road marking icon

Six of the 24 icons symbolizing road markings can be programmed as individual presets for each series ID and will be ready for selection when a series ID is selected.
Press the MENU button and select **SERIES-ID** to enter the **SERIES ID** menu:

SERIES-ID ▲▼OK
ACTIVATE: OFF
ENTER ID
EDIT
DELETE
PRESET ROAD MARKINGS
HIGHWAY #10 used: 6/200

This menu shows in the bottom of the display the name of the actual series, the number of used series out of the total and the current preset row of markings for the actual series.

To edit the preset marking icons, highlight the **PRESET ROAD MARKINGS** and press the OK button to show **THE SELECT PRESETS** menu:

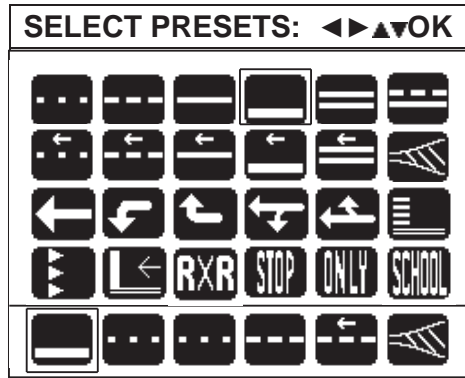

The bottom line shows the present six preset icons.

Use the LEFT, RIGHT, UP and DOWN buttons to choose a new icon for the first position, accept by pressing the OK button and the cursor (frame) will move to the second icon. Repeat for all six icons and the programming is done. You can amend at any point by pressing the BACK button and start over again.

THE LOG

Each time a measurement is taken data is stored to the log. The following data are saved, if enabled:

- Measurement result incl. average
- Date and time.
- Name of measuring series (road name) and sequence number.
- Road marking icon
- User initials.
- GPS data (if installed).
- Status

The instrument can store 1500 measurements in the log.

Clearing data in the log

Press the MENU button and select **LOG / CLEAR DATA**:

CLEAR LOG:	▲▼OK
LAST DATA	
ALL DATA	
SERIES DATA	

This menu gives the option to clear data, either the last measurement, all measurements or one of the measuring series stored in the log. By pressing the OK button you will be asked to confirm the erasure of the data:

CLEAR ALL DATA	▲▼OK
NO	
YES	

If you selected **SERIES**, you may select the series you wish to delete from the log from the list shown. Only the log entries will be erased. The series will still be available in the series select list.

Amending clear data.

The clear all option can be amended, but **only until a new measurement is taken**. To amend clearing all data, again choose **LOG / CLEAR DATA / ALL DATA**. If you have not taken a measurement after having deleted ALL DATA, the menu will now look like this:

CLEAR ALL DATA	▲▼OK
NO	EMPTY
YES	
UNDO	

Simply choose UNDO and OK to restore the log.



Viewing the log

Press the MENU button and select **LOG / VIEW LOG**:

VIEW LOG:	▲▼OK
LAST DATA	
ALL	
SERIES	

This menu gives the possibility to view or print data from either the last measurement, from all measurements or from one of the measure series stored in the log.

The figure below shows the ALL menu.

RL	TIME	STATUS	▲▼OK >
1 5 9	1 2:3 4:5 6	0	GPS
1 5 9	1 2:3 4:5 5	0	GPS
1 5 9	1 2:3 4:5 4	0	GPS NF
1 4 4	1 2:3 4:5 2	0	
1 5 8	1 2:3 4:5 1	0	
1 5 1	1 2:3 4:4 2	0	
1 5 0	1 2:3 4:2 7	0	
2001 NOV 12  : PRLC Avg:159 #1/4 HIGHWAY #10 #5/5 			

In each line, the menu shows the RL value, the time and the status, starting with the most recent measurement. To view a list of the individual errors/warnings in the status, print out the measurement (see below).

By pressing the DOWN or UP button, the individual measurements are highlighted and corresponding data are shown in the bottom of the display. These data are: date, users initials, average information, series ID, number of measurement / total measurements in that series and finally the marking icon selected (if any).

Each time a measurement is taken, a status information is generated. If any error occurs the information can be interpreted by the warning/error icon in the top line of the display. The information is available until a new measurement is taken.

The status information is also stored in the log. The status is a coded number, where 0 (zero) indicates that every thing is ok.

GPS indicates that valid GPS data was stored with the measurement. **GPS NF** indicates that the GPS had no fix during the measurement.

To get further information about the measurement the status number can be interpreted by the RSC program.

The arrow > in the top indicates that there are more entries (another page) to view, by either pressing the RIGHT button or using the DOWN button to roll the bar past the bottom.

Also, if a left arrow < appears in the top, left corner, you can access a previous page by press-

ing the LEFT button or rolling the bar out of the top by pressing the UP button.

To return to the log menu, press OK or BACK

Printing.

Press the PRINT / OUT button to print the log from the highlighted measurement to the end of (newest data) the log.

The printing can be aborted at any time by pressing and holding the PRINT / OUT button or the ON / OFF button for about 0.5 sec. Release the button as soon as the printing stops.

View series data.

In the log menu, select **SERIES** to view the list of series:

VIEW SERIES:	▲▼OK
ROAD #1	
ROAD #2	
HIGHWAY #1	
HIGHWAY #2	
HIGHWAY #3	
1	11 04 2001 - 11 04 2001

The menu shows a series ID in each line. By pressing DOWN or UP, the individual series are highlighted and corresponding number of measurements taken and the date interval for the measurement are shown in the bottom of the display. These data are: the number and the date interval for the measurement taken in the series.

Highlight a series and press the OK button to view the individual measurements.

To return to the **VIEW SERIES** menu, press the OK or the BACK button.

Printing.

Highlight a series name and press the PRINT / OUT button to print all the series data from the highlighted measurement to the end (newest data) of the log.

Highlight a measurement in the individual display and press the PRINT / OUT button to print the log from the highlighted measurement to the end of the series.

The printing can be aborted at any time by pressing and holding the PRINT / OUT button or the ON / OFF button for about 0.5 sec. Release the button as soon as the printing stops.

Log status

To see how much of the memory is used, press the MENU button and select **LOG / STATUS**:

LOG STATUS	OK
LOG USED: 104	
LOG FREE: 1396	
SERIES USED: 15	
SERIES FREE: 235	

In the case shown above, there are 104 measurements in the log, leaving room for 1396 more. There are 15 measuring series in the log, leaving room for 235 more.

Setting the log type

You can choose between two different log types:

Erase oldest: The oldest measurement will be overwritten by the newest measurement.

Warn At Full: A warning will be issued when the log is full and the measurement will **not** be saved.

Press the MENU button and select log. Highlight the line **LOG TYPE** by using the DOWN button:

LOG:	▲▼OK
CLEAR DATA	
VIEW LOG	
STATUS	
LOG TYPE: ERASE OLDEST	

By pressing the OK button you can change the type of response when the log is full.

OTHER SETTINGS

Average function

An average function can be activated showing the average of the measured R1 value calculated over a selectable number of measurements (2 to 25). The average mode can be **fixed** or **moving**. In **moving** mode the average is always calculated from the last N measurements where N is the selected number of measurements. In **fixed** mode the averaging will start over again when N measurements have been taken. The average data is shown in the HOME screen at the lower right corner (see **picture pg. 17**).

The average value is **not** stored in memory.

Press the MENU button and select AVERAGE:

AVERAGE	▲▼OK
AVERAGE:	ON
TYPE:	MOVING
NUMBER:	10
RESET	

AVERAGE:

Use the UP or DOWN button to highlight the first line. Press the OK button to toggle between *AVERAGE ON* and *AVERAGE OFF*.

TYPE:

Highlight the second line and press the OK button to toggle between type: *MOVING* and type: *FIXED*.

NUMBER:

Highlight the third line and press the OK button to focus on the NUMBER digits. Then use the UP or DOWN button to change the value between 2 and 25. Finally press the OK button to confirm the new value (or you can amend changes by pressing LEFT or BACK). The default setting is 4.

RESET:

Highlight the fourth line and press the OK button to reset the calculated average value and reset the number of measurements included in the average to zero.

Editing names

From certain points you arrive to the EDIT menu e.g. by choosing NEW from the series list.

EDIT USER:												
A	B	C	D	E	F	G	H					
I	J	K	L	M	N	O	P					
Q	R	←	DEL	INS	END							
T	U	V	W	X	Y	Z	@					
#	*	:	-	/	+	0	1					
2	3	4	5	6	7	8	9					
HANS												1/4

↓, 6 times ←

EDIT USER:												
A	B	C	D	E	F	G	H					
I	J	K	L	M	N	O	P					
Q	R	←	DEL	INS	END							
T	U	V	W	X	Y	Z	@					
#	*	:	-	/	+	0	1	2				
3	4	5	6	7	8	9						
JANS												1/4

4 times OK, →

EDIT USER:												
A	B	C	D	E	F	G	H					
I	J	K	L	M	N	O	P					
Q	R	←	DEL	INS	END							
T	U	V	W	X	Y	Z	@					
#	*	:	-	/	+	0	1					
2	3	4	5	6	7	8	9					
JANS												

OK

- Accept the highlighted letter with **OK** or select a new letter with ←, →, ↑, ↓.
To delete the marked letter: select **DEL**.
To insert before the marked letter, select **INS** (insert).
- Press the OK button to accept. The cursor moves one place to the right and the next letter is highlighted.
- Repeat 1-2 to correct or add new letters.
To move backwards, select ← and press the OK button the required no. of times. This mode is cancelled by using ←, →, ↑ or ↓.

Example: change HANS to JANS.

- Use ↓ and ← to place the upper cursor on J. Press the OK button to accept 'J' and further 3 times to accept the following letters.
This places the lower cursor after the end of the name. The upper cursor will now stay on **INS**.

Use → to select **END** and press OK to finish editing.

Finished

Diagnosis

Press the MENU button. Highlight the line **DIAGNOSIS**. Press the OK button, and the menu showing: **INSTRUMENTS, BATTERY, BOARDS** and **MISCELLANEOUS** will be seen.

Each gives information aimed at extended service and factory use. All the information will be printed out if you press the PRINT button.

Choosing output device

Press the MENU button. Highlight the line **PRINT / OUTPUT** by pressing the UP button once:

MAIN MENU	▲▼OK
SETTINGS	
SERIES-ID	
LOG	
AVERAGE	
DIAGNOSIS	
PRINT/OUTPUT:	INT.

By pressing the OK button you can change the output device:

The two possibilities are:



Int: The built-in printer will be used for output.

Ser: The communication port will be used for output.

The help system

Press the HELP button to show a context dependent help page. Pressing HELP once more will present a general help menu in which you can highlight a subject by using the UP or DOWN button and then press the OK button to show the help text.

Errors and warnings

When a measurement is taken, a status number is generated and saved in the log together with the measurement. The status number reflects various conditions concerning the measurement. If a problem occurs, a warning icon  or an error icon  is shown above the HOME screen and an audible alarm is sounded (if enabled) and error is stored in the log.

To view the nature of the problem, press the UP button and the warning/error icon will be highlighted and the most severe problem will be stated in the message line underneath.

Then press the OK button to view a total list of problems starting with the most severe.

Press the OK button (alternatively BACK or LEFT) to return to the HOME screen.

If the problem did not hinder the completion of the measurement, the erroneous RI value will be saved in the log together with a status number, which can identify the problems when the log is evaluated using the RSC program.

Default settings / user reset

At power up a combination of buttons can be pressed to reset the active instrument setting and restoring the default settings.

Forced English menu and standard contrast:

If the instrument is set to a foreign language and you can not find the language select menu, do the following:

Turn off the instrument.

Press and hold the  button while turning on the instrument.

Now you can find the language select menu and select the language you want. If you do not set a language the foreign language will return at the next start-up.

Small factory reset:

This non destructive reset can be used to set parameters to factory standards but will **not** erase the log, the series list, the user list or the preferred markings:

Turn off the instrument.

Press and hold the  button while turning on the instrument.

Factory reset:

This will set all parameters to factory standards **and will also erase the log, the series list and the user list:**

Turn off the instrument.

Press and hold the  and  buttons while turning on the instrument.

RSC program

Main features of the RSC program delivered together with the LTL-X:

- Transfer of log data to a pc
- Export of log data to other programs e.g. spread sheets
- Printing reports of the log data
- Easy entry of series-ID to make your measurement task efficient and reliable
- Programmable user setup

For more details see the separate user's manual for the RSC program, found on the installation CD.

SECTION 4

MAINTENANCE

General care

The retrometer is constructed for outdoor use in ordinary good weather conditions. It will stand moist weather with wet roads, but caution must be taken against heavy rain and dirt. The LTL-X retrometer is an optical instrument and shall be handled as such. Avoid shock and vibration if possible.

CAUTION!

To reduce the risk of electrical shock, do not remove the cover.

Protection window

The protection window is accessible from underneath of the instrument. The protection window is coated with a high-efficiency anti-reflection coating. Take care not to damage this coating when cleaning. Compressed air or a fine brush can be used for removing loose particles/dust. If this is not sufficient the window should be cleaned using a soft paper tissue or cloth and some window cleaning liquid.

Battery

The LTL-X retrometer is powered by a 12V NiMH battery. Under normal use, this battery requires no maintenance. However it is recommended to keep the battery fully charged. A fully charged battery is more capable of withstanding degeneration.

A battery charger power supply is provided as a standard accessory for charging the battery from mains. The output cable of the charger is equipped with a connector matching the connector in the instrument. Connect the charger to an outlet and the instrument.

If the instrument was turned off the display will now show a moving text that explains the charging state (Charging/Trickle charging/Charging done/Is Charged and Charge Error). The battery icon in the upper right corner will also indicate the charging state.

No harm will result from leaving the charger connected after the charging process. However, the instrument must be disconnected from the charger when disconnecting the battery from the wall outlet.

In addition, the battery can be charged using any DC supply from 12-18 V. such as a car battery by using an inverter.

When storing the instrument for a long period of time fully charge the battery.

It is possible to install a larger battery pack to increase the operating time for the instrument. This is also recommended when using a GPS.

Replacing the battery

A worn out battery will not hold a charge very long. When the battery is worn out it must be replaced. The user can do this.

The battery is located in a compartment at the rear of the tower. To replace the battery, remove the screws from the back cover, and remove the cover



Loosen the big screw at the battery cover. You can now remove the cover.

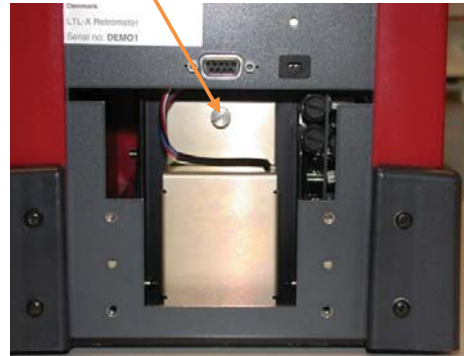

Lift out the battery of the compartment

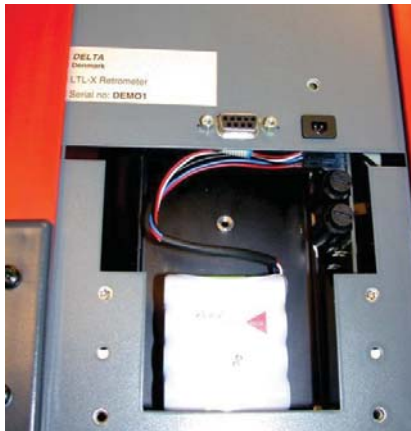





Press the snap-on clip on the connector and carefully withdraw it from the printed circuit board



The battery can now be removed and replaced. Refit in reverse order. Please check your local regulations for disposal of the battery.

Battery status

The capacity of the battery can be seen from the icon in the upper icon row.

-  Indicates that the battery is fully charged.
-  Indicates that the capacity of the battery is high to fair
-  The capacity is low. You should recharge the battery.
-  The battery is almost empty.

The battery voltage is shown as it was **at the last measurement** in idle (when the instrument is on but not taking a reading) and in loaded mode (when xenon lamp is charging). Select the battery icon (with UP, LEFT and OK). The display will then show the voltages.

Fuses

Two fuses are located in the battery compartment. The charging fuse protects the battery against short circuit and other errors in the charging connector, charger or charging system. The battery fuse protects the battery and electronics against short circuit and other errors in the electronic system.

Always replace a blown fuse with one of equal rating **See Electrical Characteristics pg. Error! Bookmark not defined.** To change the fuses you need access to the battery compartment. **See replacing battery pg. 42.** Carefully unscrew the plastic cap fuse holder by using e.g. a coin. Pull out the fuse from the cap and insert the new one and reassemble

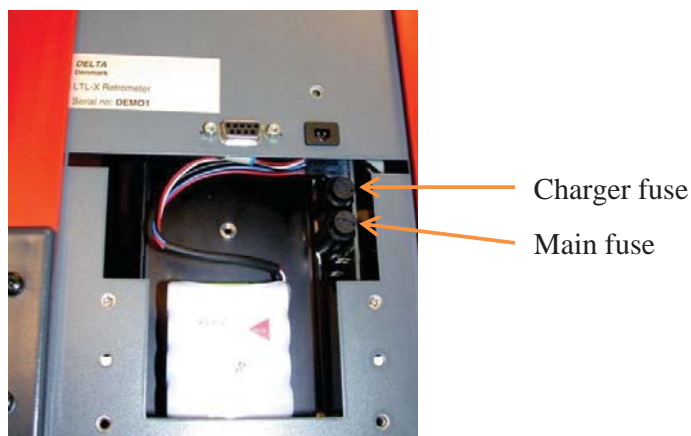

Lamp

The lamp is a long life xenon type and requires no maintenance. Only trained personnel should replace the lamp when replacement is required.

Calibration unit

Reference

The road marking is simulated by a piece of white ceramic (the reference) mounted on an aluminum profile. Ceramics have very stable optical properties because of the smooth surface.

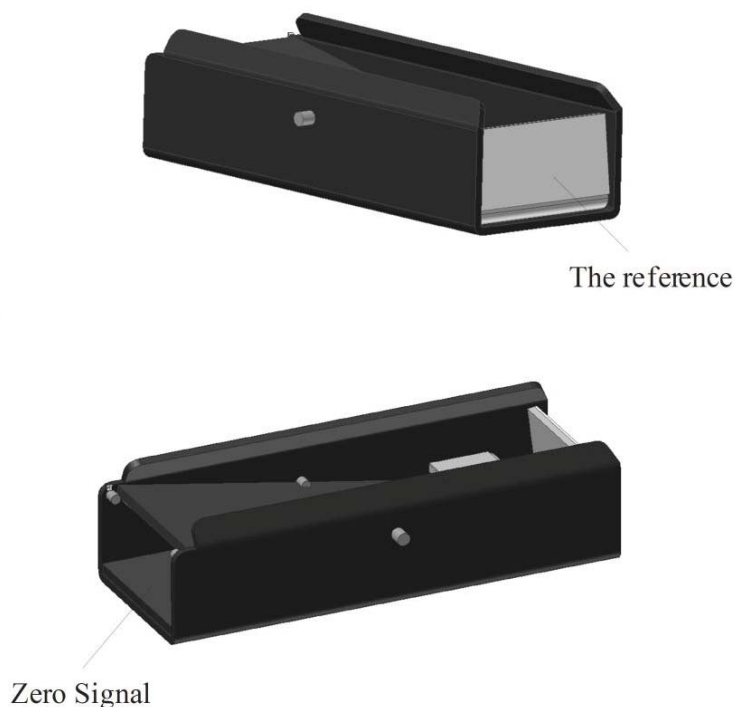

Figure: 5 - Calibration normal

To make sure that calibration of the retrometer is correct it is important that the ceramics and light trap on the calibration unit is clean and undamaged. Always keep the calibration unit well protected.

If the ceramic is stained, scratched or broken, the calibration unit has to be replaced and calibrated. In case of dust on the ceramics surface of the traceable reference, the use of compressed air is recommended for removal. To clean the ceramic reference on the field calibration unit, the use of a soft damp cloth is recommended if compressed air fails to remove the dirt. If necessary, use a mild household detergent. A calibration transfer must always be completed after the field reference is cleaned. It is necessary to have the traceable reference available to perform the transfer prior to cleaning the field reference.

To ensure reliable measurements, it is recommended that the calibration unit be periodically recalibrated to a traceable standard. DELTA Light & Optics offers calibration traceable to PTB (Physikalsich-Technische Bundesanstalt). For information contact your distributor or DELTA.

Light trap

The zero signal is simulated by a light trap mounted in the calibration unit in the opposite end of the reference. It is made of two glossy and black plastic sheets mounted at an acute angle. If clean this will provide very efficient light absorbing device.

It is necessary to disassemble the light trap to clean it efficiently. Using a fine brush, clean pressurized air or a soft paper tissue/cloth and some window cleaning liquid can do the cleaning.

Calibration

The LTL-X is factory calibrated and very stable but a calibration should always be carried out before starting a new series of measurements.

The instrument is supplied with two calibration units, a reference calibration unit (black) and a field calibration unit (red). The reference calibration unit is factory calibrated and traceable to PTB. The field calibration unit must be calibrated against the reference calibration unit by the user at suitable intervals. The reference calibration unit is stored in the black protection box, and the field calibration unit in the gray protection box.



Figure: 6 – Calibration

Calibration

Two steps are required for a complete calibration, *zero calibration* and *reference calibration*. The instrument will guide you through the procedure.

Calibration procedure

- *Zero calibration*

Press the CALIBRATION button  once. Mount the instrument upon the calibration unit. This is done by tilting the instrument slightly backward and then insert the unit underneath the front end of the instrument. Make sure that the pins on the side of the unit fit into the slots in the LTL-X.

It is important that the calibration unit faces with the dark opening towards the instrument tower. The display will show the correct orientation of the calibration unit. Make sure that the calibration unit and the light trap are clean.

Press the OK button to start *zero calibration*. During calibration the lamp will flash a number of times.

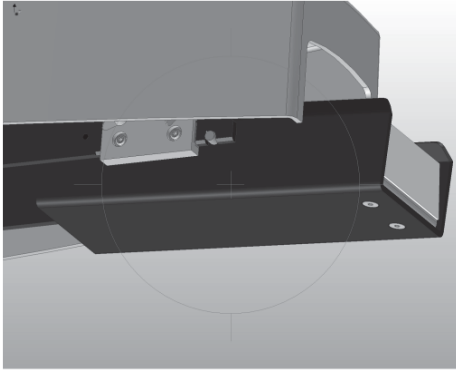

Figure: 7 – Placing the calibration normal.

- *Reference calibration*

Now the instrument is ready for the next step and the display will tell you to rotate the calibration unit so that the white face is facing the instrument tower. Again it is important that the pins on the side of the unit fit into the slots in the LTL-X. Press OK to begin the reference calibration. Check the value displayed and if necessary adjust the calibration value shown in the display, so it matches the value stamped on the calibration unit.

Press the OK button to perform the calibration.

The calibration procedure is now complete. Remove the calibration unit and store it properly. Press OK to return to the measurement display.

The instrument automatically compensates for zero signal, leakage and other known errors, and calculates a calibration factor. This process is fully automatic. If the calibration routine is followed precisely the retrometer will now display '**true**' RI.

Always store the reference calibration unit in a dry and clean environment.

Printer

The printer is a high-speed high quality mini thermal printer. It has only a few moving parts and does not require any special or periodic maintenance.

It uses a thermal paper roll, width: 57.5 ± 0.5 mm (2.26 in), diameter: max. 31 mm (1.22 in)

Replacing paper

Replacing the paper is simple. First, pull the little lever out with your finger and the cover will open into the paper roll compartment.

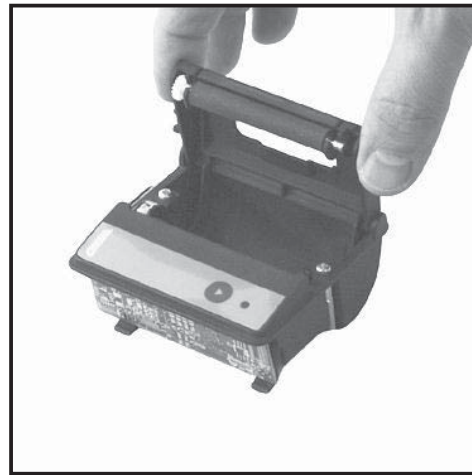
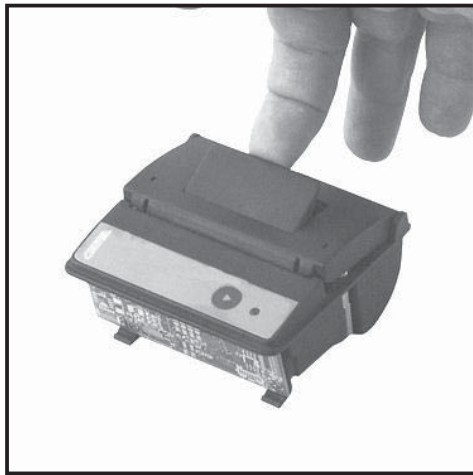

Insert the new paper roll and let a short paper tail hanging out at the top. Close the cover with a firm push and with some of the paper sticking out.

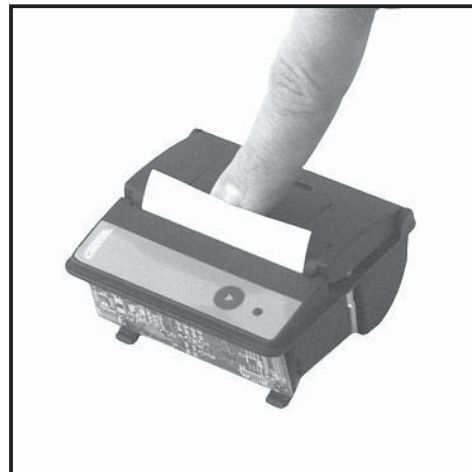
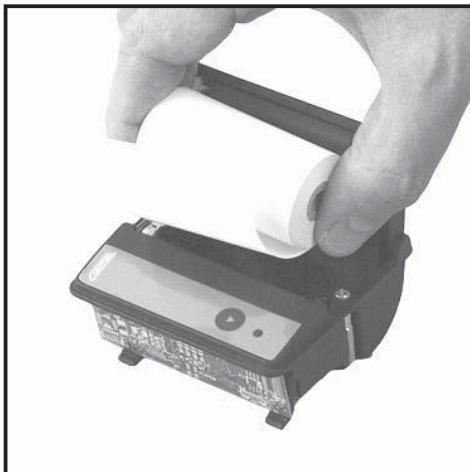

Mounting the wet night rails for rain measurements

In order to move the measurement field outside the horizontal base cover as shown on figure 3, page 15 the two wet night rails should be mounted.



You will find two wet night rails in the carrying case. Be aware of that there is a left and a right one.



Bushing for the wet night rail

Mount the wet night rails by insert the rails into the bushing underneath the LTL-X





Fasten the wet night rails in the lid with the screws delivered with the rails. Make sure that the LTL-X is resting on the rails before lightening the screws.



The Wet night rails are now ready for use. After use dismount the wet night feet by reversing above operations.

Mounting the wheel unit (option)

A wheel unit can be mounted in the rear of the instrument for easy transportation during heavy use.

The wheels are mounted easily to the rear by fastening the two nuts mounted on the wheel block.

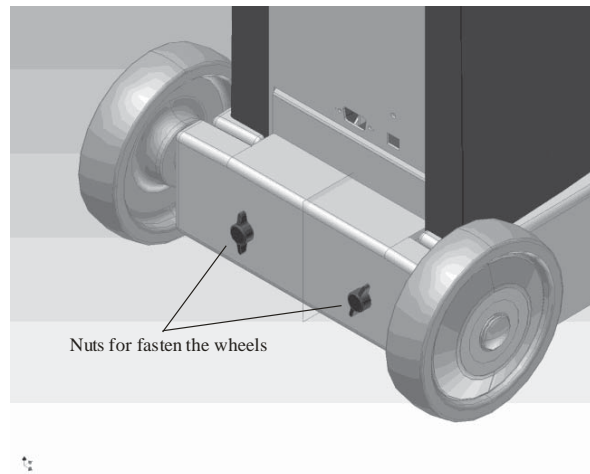

Figure: 10 – Mounting the wheels

APPENDIX A

COMMUNICATION FACILITIES

Communication specification

LTL-X is equipped with a USB connection that enables the use of standard Windows PC for downloading measurement records from the internal data log

The PC connects to the LTL-X using the USB device connector on the rear of the instrument and a cable coming with the instrument.

APPENDIX B

SPECIFICATION

General characteristics

Illumination angle..... 1.24°
Observation angle 2.29°
Equivalent observer distance 30 m

Observation angular spread ±0.17°

Type 30m CEN

Illumination angular spread horizontal 0.33°

Illumination angular spread vertical 0.17°

Field of measurement:

Width..... 50 mm (2.0 inch)

Length (typ.)..... 200 mm (7.9 inch)

Min. reading ($\text{mcd}\cdot\text{m}^2\cdot\text{lx}^{-1}$) 0

Max. reading ($\text{mcd}\cdot\text{m}^2\cdot\text{lx}^{-1}$)..... Typ. 2000

Radio: EN 300440-1 V1.6.1:2010

EMC: EN 301489-1 V1.8.1:2008, EN 301489-3 V1.4.1:2002

Safety : EN/IEC 60950-1 :2006, EN/IEC 60950-22 :2006

FCC: 47 CFR, FCC Part 15B, Class A

Power supply:

Battery Built in 12 volt / 2.1 Ah NiMH

External charger power supply Friwo FW7530/15 (100-240 VAC / 15VDC)

Charging time..... Approx. 1 hour 50 min

Charger fuse (5*20 mm) T3.15A

Power supply fuse (5*20 mm) T3.15A

Data memory 1500 measurements

Data retention (from purchase)..... Typ. 5 years

Interface USB

Environmental characteristics

Temperature:

Operating..... 0°C to + 45°C (32°F to +113° F)

Storage^{*)} -15°C to + 55°C (5° F to +131° F)

Humidity..... 85% and non-condensing

^{*)} Battery must be fully charged

Mechanical characteristics

Max. length.....573 mm/ 22.56 in

Max. width..... 222 mm/ 8.74 in

Max. height..... 538 mm/ 21.18 in

Weight9 kg/ 20 lbs

Shipping weight.....20 kg/ 45 lbs

Construction:

Structural parts Aluminum

Housing Polymer

Keyboard..... Silicone rubber

Circuit boards..... Epoxy glass

Printer:

Thermal paperwidth/dia. 57.5 ±0.5 mm / 31mm (2.26 in / 1.22in)

APPENDIX C

DELIVERY



INDEX

3

30 meters · 5

A

Advanced · 26
Amending clear data · 31
Auto off · 27
Aux functions · 24
Average function · 35
 Fixed · 35
 Moving · 35
 Number · 35
 Reset · 35
 Type · 35

B

Back light (display) · 23
Battery · 39
 Charging · 39
 maintenance · 39
 status · 41
Battery status · 41
Buttons · *See* Pushbuttons

C

Calibration · 43
Calibration procedure · 43
Calibration unit · 42
 Light trap · 43
 Reference · 42
CEP · 26
Clear user · 20
Clearing data in the log · 31
Communication · 49
Communication specification · 49
Continuous wetting · 12
Contrast · 23

D

Date · 21
Datum, Map · 26
Deactivating the profile icon · 21
Default settings · 38
Delayed off timer · 25
DELIVERY · 52
Detector · *See* Photo detector
DGPS · 25
Diagnosis · 37
Display · 23
Display shield · 11

E

Editing names · 36
EGNOS · 25
Electrical characteristics · 50
Enter a new series id · 28
Environmental characteristics · 51
Error icon · 37
Error sources · 14
Errors and warnings · 37

F

Fixed · 35
Fuses · 41

G

General care · 39
GPS · 24
 Activating the GPS · 24, 25
 HDOP · 26
GPS data · 25
Group · 28

H

Help · 37
HOME screen · 15

I

Illumination field · 12, 13
Initials · 19
Int, Internal printout · 37

K

Key · *See* Pushbuttons

L

Label · 28
Lamp · 41
Language · 23
Leakage · *See* Stray light
Light trap · 43
Lightness of the road · 5
Log · 31
Log status · 33
Log type · 34
Low battery voltage · 7
Lower icon row · 16

M

Maintenance · 39
Map datum · 26
Measure display · 15
Measurement · 12
Measurement field · 12
measurement, number · 10
Mechanical characteristics · 51
Menu display · 15
Menu tree · 18
Mounting the plates/ feet's for rain measurements · 46
Moving · 35

N

Name · 28
Navigation performance · 26
New series id · 28
Notes on error sources · 14
 Display · 14
 High temp. · 14
 Sun · 14

O

Observation field · 12, 13
Off timer · 25
Operator · 19
Optical principle · 13
Output device · 37

P

Photo detector · 13
Placement on the road · 14
Power save · 27
Preset profiles · 29
Printer · 45
Protection window · 39
Pushbuttons · 16
 Back · 16
 Calibrate · 16
 Help · 16
 Home · 16
 Menu · 16
 OK · 16
 ON/OFF · 16
 Print/Out · 16
 SMART · 16

R

Rain measurements · 46
Receiver · 24
Reference · 42
Reference calibration · 44
Removing a series id · 29
Replacing the battery · 40

Reset · 38
RI · 5, 7
Road icon · 28
Road marking profiles · 29
RSC-program · 38

S

SEL. AT START · 20
Select at start · 20
Ser, Serial output · 37
Series id · 28
Setting the log type · 34
Setting the preset profiles · 29
Setup · 26
 Advanced · 26
SMART key · 23
Sound level · 23
Specifications · 50
Stray light · 14

T

Time · 21
Traceable · 42

U

Upper icon row · 15
User id · 19
User interface · 15
User reset · 38
Users · 26

V

View series data · 33
Viewing the log · 32

W

Warning icon · 37
Warnings · 37
Wheel unit · 48
Window · 39
WAAS · 25

X

Xenon lamp · 13

Z

Zero calibration · 43

RSC2

SOFTWARE MANUAL



We help ideas meet the real world

RSC2 Manual

Road Sensor Control Software for Retrometer LTL-X



DISCLAIMER

The information contained in this document is subject to change without notice.

DELTA LIGHT & OPTICS MAKES NO WARRANTY OF ANY KIND WITH REGARD TO THIS MATERIAL, INCLUDING, BUT NOT LIMITED TO, THE IMPLIED WARRANTIES OF MERCHANTABILITY AND FITNESS FOR A PARTICULAR PURPOSE. DELTA LIGHT & OPTICS SHALL NOT BE LIABLE FOR ERRORS CONTAINED HEREIN OR FOR INCIDENTAL OR CONSEQUENTIAL DAMAGES IN CONNECTION WITH THE FURNISHING, PERFORMANCE OR USE OF THIS MATERIAL.

NOTE: THIS EQUIPMENT HAS BEEN TESTED AND FOUND TO COMPLY WITH THE LIMITS FOR A CLASS A DIGITAL DEVICE, PURSUANT TO PART 15 OF THE FCC RULES. THESE LIMITS ARE DESIGNED TO PROVIDE REASONABLE PROTECTION AGAINST HARMFUL INTERFERENCE WHEN THE EQUIPMENT IS OPERATED IN A COMMERCIAL ENVIRONMENT. THIS EQUIPMENT GENERATES, USES, AND CAN RADIATE RADIO FREQUENCY ENERGY AND, IF NOT INSTALLED AND USED IN ACCORDANCE WITH THE INSTRUCTION MANUAL, MAY CAUSE HARMFUL INTERFERENCE TO RADIO COMMUNICATIONS. OPERATION OF THIS EQUIPMENT IN A RESIDENTIAL AREA IS LIKELY TO CAUSE HARMFUL INTERFERENCE IN WHICH CASE THE USER WILL BE REQUIRED TO CORRECT THE INTERFERENCE AT OWN EXPENSE.

Revision June 2012

RSC2-program

The Road Sensor Control program, RSC2, is intended for managing your work with the LTL-X.

RSC2 provides the following features:

- Setting up user profiles
- Project Planning
- Log management

Requirements

The program will run on computers with Windows XP or higher installed. Connection to the PC is via USB.

Installation

Insert the RSC2 CD-ROM into your CDROM drive and the installation will start automatic. If the AutoRun feature is disabled on your computer run /SETUP.EXE directly from the CDROM.

Setup installs RSC2 in the specified location and creates an RSC2 icon on the desktop and a shortcut in the start menu.

RSC2 layout

In RSC2 you can select among multiple pages, by selecting the tabs below the menu bar.

The available tabs are:

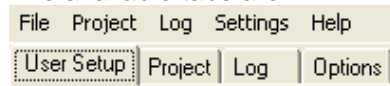

On all tabbed screens you have a status bar, which holds information about the LTL-X and RSC2 setup.

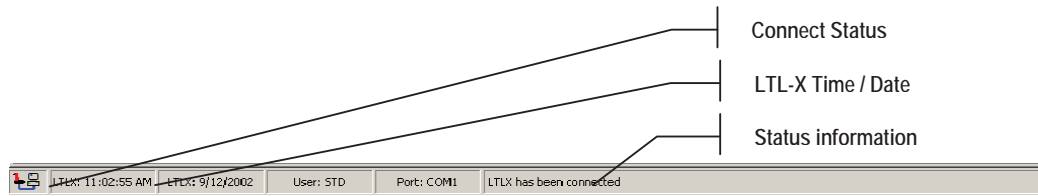

The Connect Status Icon shows if a LTL-X is connected or not. When no LTL-X is connected, this icon will be gray.

The time and date field is continuously updated from the LTL-X. If the LTL-X is disconnected or turned off, the time and date will disappear. The time will be shown in the format corresponding to your current regional Windows settings.

The selected user name and active communication port is also shown in the status bar and finally, status information, informing you about the status of your actions.

User profiles

RSC2 provides a range of individual user-settings; these settings may be saved as a *User profile* in RSC2. The user profiles may be prepared and stored in the RSC2 program for later upload to LTL-X.

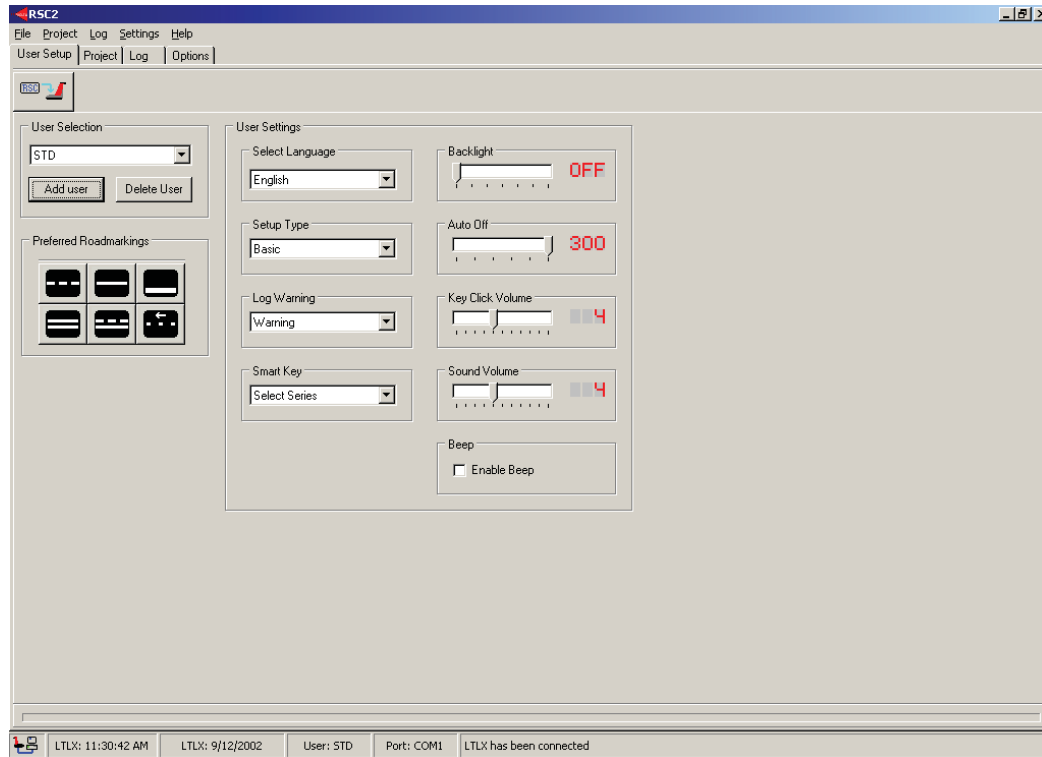

User Setup

In RSC2 you can change the following LTL-X user settings:

Language selection:

Select a Language in LTL-X. This setting only affects the language in LTL-X.

Setup Type:

Basic or Advanced setup-type may be selected. By selecting Basic, several settings will not be displayed in LTL-X (see the LTL-X manual for details).

Log Warning:

The Log can hold more than 1500 measurements. By selecting "Warning" a warning will be displayed, when the log is full. When "Overwrite" is selected, the oldest measurement will be overwritten, without a warning (see the LTL-X manual for details).

Smart Key Function:

Smart Key lets you assign a dedicated function to the LTL-X smart-key.

Backlight:

Backlight timer that controls the LCD Backlight turn on time, max time is 30 seconds.

Auto Off:

Auto Off timer determines how long the LTL-X stays on if no user activity is detected. Available Auto Off values are: OFF, 60, 120, 180, 240 or 300 seconds.

Key Click Volume:

Key Click Volume sets the key-click sound.

Sound Volume:

Sound Volume sets the systems sound volume.

Beep:

Enable the Beep sound after completing a measurement by selecting Beep Enable.

Preferred road-markings:

Preferred Project Road Markings displays the selected predefined road markings used when a new Series ID is added to a project (in the project pane). The markings are uploaded to LTL-X together with the project Series ID.

By double clicking the marking a window is displayed allowing you to select your preferred markings from a list.

Preparing a profile:

1. Select the "User-setup"-pane in the RSC2-program
2. Press "Add User" button.

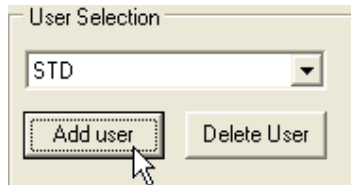

3. Enter your initials in the User-selection box.

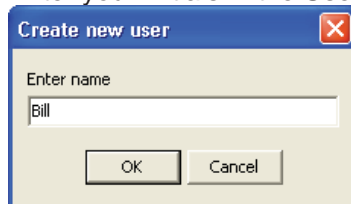

4. Customize your profile, by selecting the different settings.

Removing a user profile:

1. Select the user you want to remove
2. Press "Delete User"

Storing user-profiles

User-profiles are automatically saved in an Ini file, when the RSC2 program is closed.

Uploading a profile

Press the “Upload User settings” button



When you upload a user profile to the LTL-X, RSC2 searches the list of users currently in the instrument, if the new username already exist in the LTL-X, the user settings for that username will be updated. RSC2 treats the list of user names as a history list. If the upper six users in this list also exist in the LTL-X, RSC2 will replace the names from the bottom to the top, of this list, i.e. the username at the bottom of the username list in RSC will be the first to be replaced in LTL-X.

RSC2 can't replace username 7 or 8 in the LTL-X by other usernames. However RSC2 is able to update the settings of these users, if the same username is created in RSC2. The names of user 7 and 8 must therefore be changed manually in LTL-X.

Project pane:

In the Project pane you can manage a project, for later upload.

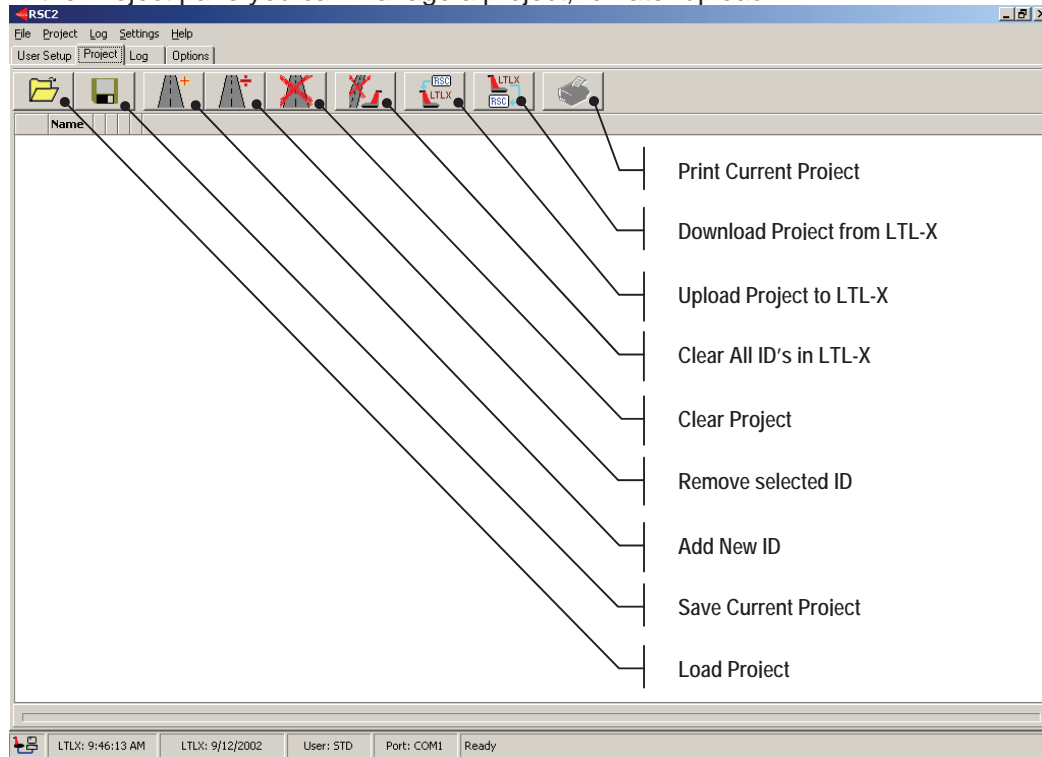

Create a new project:

1. Press the Add New ID button 
2. Enter a name for the ID
3. Press Enter

When you add an ID, six Road Markings will be displayed. These markings are identical to the preferred markings setup for the current RSC2 user. However, the markings can be changed by double clicking on them individually and then select a new marking from the list.

To append an ID between two existing ID's press the CTRL while clicking the 

Double click on the Series ID name to change it.

If an ID containing more than 19 letters is entered, the ID will be truncated after prompting the user.

The purpose of a series ID

The Series ID is a label. For example, it could be the name of the road.

Although measurements can be performed without selecting a Series ID, it is convenient to group (name) the measurements for each geographical spot, road or part of a road for easier recognition of each measurement.

The Series ID for such a group of measurements will be saved in the log together with the measuring results. The ID must be selected prior to the measurement.

Uploading a project to LTL-X

To upload a project to the LTL-X, just press the Upload button.

When uploaded, you can select the Series ID on LTL-X by clicking on the  icon in the top row of the LTL-X measure window.

Downloading a project to RSC

To append the ID's from the LTLX to your current project, press the Download button. If you want your project to contain the ID's in LTL-X, you should clear the project page before you download the project to RSC.

Saving a project:

If you want to save the project on the pc for later use, press the Save button.

Loading a project

To open a project file, press the Load Project button.

The project files are text files that can be edited in a normal text editor. Each line in the text file represents a Series ID, normally the ID is followed by 6 comma separated numbers, representing the 6 road markings. If only an ID is provided, the Preferred Marking, from the user setup will be used. If a line in the project file contains between 1 and 5 markings, an error message is displayed.

If an ID contains more than 19 letters, the ID will be truncated after prompting the user.

Printing a project

Press the Print Project button. The print button will be disabled, if the ID list is empty.

Clearing a Project

If you want to delete your project, press the Clear Project button.

Clear LTL-X ID's

If you want to delete **all** Series ID's stored in the LTL-X, press the Clear LTL-X ID's.

Note: All log data with Series ID will be deleted!

Log pane

In the Log pane you can read the data stored in the LTL-X Log.

By selecting the Read Log button  the whole log content will be downloaded from the LTL-X.

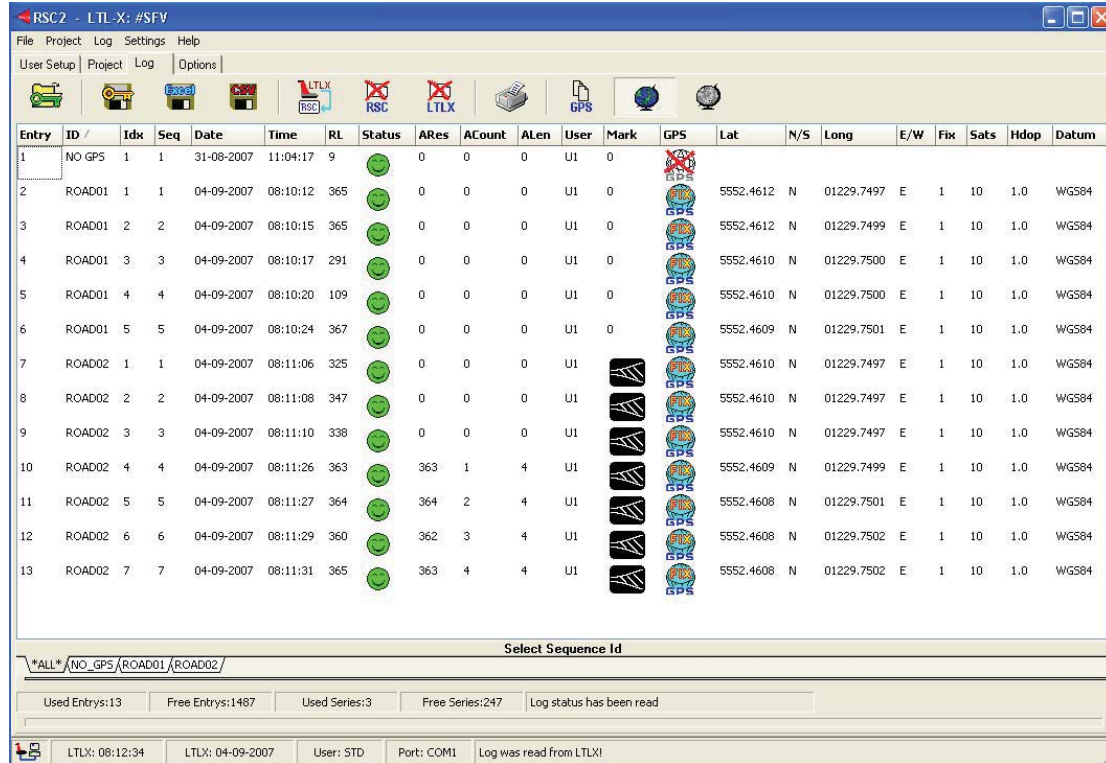

Entry	ID /	Idx	Seq	Date	Time	RL	Status	ARes	ACount	ALen	User	Mark	GPS	Lat	N/S	Long	E/W	Fix	Sats	Hdop	Datum	
1	NO GPS	1	1	31-08-2007	11:04:17	9		0	0	0	U1	0										
2	ROAD01	1	1	04-09-2007	08:10:12	365		0	0	0	U1	0		5552.4612	N	01229.7497	E	1	10	1.0	WGS84	
3	ROAD01	2	2	04-09-2007	08:10:15	365		0	0	0	U1	0		5552.4612	N	01229.7499	E	1	10	1.0	WGS84	
4	ROAD01	3	3	04-09-2007	08:10:17	291		0	0	0	U1	0		5552.4610	N	01229.7500	E	1	10	1.0	WGS84	
5	ROAD01	4	4	04-09-2007	08:10:20	109		0	0	0	U1	0		5552.4610	N	01229.7500	E	1	10	1.0	WGS84	
6	ROAD01	5	5	04-09-2007	08:10:24	367		0	0	0	U1	0		5552.4609	N	01229.7501	E	1	10	1.0	WGS84	
7	ROAD02	1	1	04-09-2007	08:11:06	325		0	0	0	U1			5552.4610	N	01229.7497	E	1	10	1.0	WGS84	
8	ROAD02	2	2	04-09-2007	08:11:08	347		0	0	0	U1			5552.4610	N	01229.7497	E	1	10	1.0	WGS84	
9	ROAD02	3	3	04-09-2007	08:11:10	338		0	0	0	U1			5552.4610	N	01229.7497	E	1	10	1.0	WGS84	
10	ROAD02	4	4	04-09-2007	08:11:26	363		363	1	4	U1			5552.4609	N	01229.7499	E	1	10	1.0	WGS84	
11	ROAD02	5	5	04-09-2007	08:11:27	364		364	2	4	U1			5552.4608	N	01229.7501	E	1	10	1.0	WGS84	
12	ROAD02	6	6	04-09-2007	08:11:29	360		362	3	4	U1			5552.4608	N	01229.7502	E	1	10	1.0	WGS84	
13	ROAD02	7	7	04-09-2007	08:11:31	365		363	4	4	U1			5552.4608	N	01229.7502	E	1	10	1.0	WGS84	

In the log pane you see a row of tool buttons:



From left to right, the toolbar holds the following buttons:

- Open protected file
- Save protected file
- Save Excel file
- Save CSV file
- Download Log from LTL-X into Log page
- Clear RSC2 Log page
- Clear LTL-X Log
- Print Log page
- Copy the GPS position of the selected row to clipboard.
- Show GPS positions
- Export to Google Earth

A Log page:

Entry	ID /	Idx	Seq	Date	Time	RL	Status	ARes	ACount	ALen	User	Mark	GPS	Lat	N/S	Long	E/W	Fix	Sats	Hdop	Datum
2	ROAD01	1	1	04-09-2007	08:10:12	365		0	0	0	U1	0		5552.4612	N	01229.7497	E	1	10	1.0	WGS84

And an extra Log status bar:

Used Entrys:13	Free Entrys:1487	Used Series:3	Free Series:247	Log status has been read
----------------	------------------	---------------	-----------------	--------------------------

When the LTL-X is connected, the log status bar holds information about log usage. The number of used and free entries and series is displayed.

If Series ID's are used during measuring the log page will contain several tabs

ALL **NO_GPS** **ROAD01** **ROAD02** named with the Series ID plus one showing all the data. The tabs will act like a filter showing only the respective data. The selected tab will become the active log page.

All selected:

Entry	ID /	Idx	Seq	Date	Time	RL	Status	ARes	ACount	ALen	User	Mark	GPS	Lat	N/S	Long	E/W	Fix	Sats	Hdop	Datum	
1	NO GPS	1	1	31-08-2007	11:04:17	9		0	0	0	U1	0										
2	ROAD01	1	1	04-09-2007	08:10:12	365		0	0	0	U1	0		5552.4612	N	01229.7497	E	1	10	1.0	WGS84	
3	ROAD01	2	2	04-09-2007	08:10:15	365		0	0	0	U1	0		5552.4612	N	01229.7499	E	1	10	1.0	WGS84	
4	ROAD01	3	3	04-09-2007	08:10:17	291		0	0	0	U1	0		5552.4610	N	01229.7500	E	1	10	1.0	WGS84	
5	ROAD01	4	4	04-09-2007	08:10:20	109		0	0	0	U1	0		5552.4610	N	01229.7500	E	1	10	1.0	WGS84	
6	ROAD01	5	5	04-09-2007	08:10:24	367		0	0	0	U1	0		5552.4609	N	01229.7501	E	1	10	1.0	WGS84	
7	ROAD02	1	1	04-09-2007	08:11:06	325		0	0	0	U1			5552.4610	N	01229.7497	E	1	10	1.0	WGS84	
8	ROAD02	2	2	04-09-2007	08:11:08	347		0	0	0	U1			5552.4610	N	01229.7497	E	1	10	1.0	WGS84	
9	ROAD02	3	3	04-09-2007	08:11:10	338		0	0	0	U1			5552.4610	N	01229.7497	E	1	10	1.0	WGS84	
10	ROAD02	4	4	04-09-2007	08:11:26	363		363	1	4	U1			5552.4609	N	01229.7499	E	1	10	1.0	WGS84	
11	ROAD02	5	5	04-09-2007	08:11:27	364		364	2	4	U1			5552.4608	N	01229.7501	E	1	10	1.0	WGS84	
12	ROAD02	6	6	04-09-2007	08:11:29	360		362	3	4	U1			5552.4608	N	01229.7502	E	1	10	1.0	WGS84	
13	ROAD02	7	7	04-09-2007	08:11:31	365		363	4	4	U1			5552.4608	N	01229.7502	E	1	10	1.0	WGS84	

Select Sequence Id

ALL NO_GPS ROAD01 ROAD02

Used Entrys:13 Free Entrys:1487 Used Series:3 Free Series:247 Log status has been read

LTLX: 08:44:14 LTLX: 04-09-2007 User: STD Port: COM1 Ready

Road01 selected:

Entry	ID /	Idx	Seq	Date	Time	RL	Status	ARes	ACount	ALen	User	Mark	GPS	Lat	N/S	Long	E/W	Fix	Sats	Hdop	Datum
2	ROAD01	1	1	04-09-2007	08:10:12	365	●	0	0	0	U1	0	GPS	5552.4612	N	01229.7497	E	1	10	1.0	WGS84
3	ROAD01	2	2	04-09-2007	08:10:15	365	●	0	0	0	U1	0	GPS	5552.4612	N	01229.7499	E	1	10	1.0	WGS84
4	ROAD01	3	3	04-09-2007	08:10:17	291	●	0	0	0	U1	0	GPS	5552.4610	N	01229.7500	E	1	10	1.0	WGS84
5	ROAD01	4	4	04-09-2007	08:10:20	109	●	0	0	0	U1	0	GPS	5552.4610	N	01229.7500	E	1	10	1.0	WGS84
6	ROAD01	5	5	04-09-2007	08:10:24	367	●	0	0	0	U1	0	GPS	5552.4609	N	01229.7501	E	1	10	1.0	WGS84

Select Sequence Id
 ALL/(NO_GPS)/ROAD01/ROAD02/

Used Entries:13 Free Entries:1487 Used Series:3 Free Series:247 Log status has been read

LTLX: 08:43:07 LTLX: 04-09-2007 User: STD Port: COM1 Ready

Note: the user can change uploaded log data at any time by double clicking the cell where data is going to be changed. These changes are reflected in both Excel and CSV files; however, the protected file will always contain the original data.

Loading a Protected file

You can open a Protected file by pressing this button.

A Protected file is an encrypted log file, having the extension RSC. The purpose of the Protected file is to secure your work. By saving or forwarding a Protected file, you can document that your work has not been manipulated. Encrypted Protected files can only be loaded and used in the RSC2 program.

Saving a Protected file

When the log has been read, you may want to save it in a Protected file-format.

Even if you edit the Log page, and manipulate the data, the original data is retained, and you can save it at any time.

Saving an Excel file

The active log page may be saved as an Excel file at any time. The Excel file will, however not contain any graphical presentation, i.e. Road Markings. Graphical information's will be shown as a number.

Saving a CSV file

You may save the active log page as a Comma Separated file. This ensures that you can export log data to almost any other application.

Clear RSC2 Log

The Clear Page button lets you clear the Log page on your computer.

Clear LTL-X Log

The Clear Log button lets you clear the Log in the LTL-X. When this is done, **all log data in the LTL-X will be lost.**

Print Log

The Print Log button lets you print the contents of active log page.

Show GPS Position

When you press this button, the GPS information will be displayed in the Log page. If you choose to save the Log page, the information will be preserved, even if the GPS position is hidden.

Export GPS data to Google Earth

You can export log data containing GPS positions to Google Earth.

Before exporting data you must select the data lines to be shown. If no data are selected the program will automatically select all data lines.

Data can be selected by using the regular windows way:

shift + left mouse click selects a group.

ctrl + left mouse click selects / deselects single entries.

When you press this button , a new window will open to setup the parameters for the export.

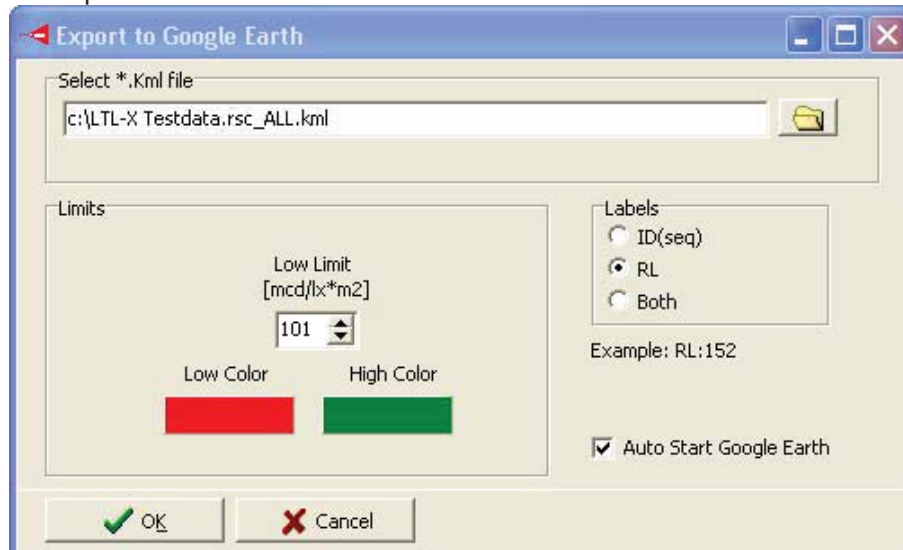

If log data represents downloaded data (not data from a protected file) the file name will be a combination of the instrument (LTL-X), the serial number (e.g. 515) and the selected Series ID. The extension must be .kml.

In the *Limits* section you can enter a value controlling the appearance of the data shown in Google Earth (GE). RI values less than the value in the low limit box will be shown with the low color. RI values higher will be shown with the high color.

In the *Labels* section you can decide the appearance of the text shown on the measurements shown on the screen. In the example below ID(seq) are shown

If *Auto start Google Earth* is checked GE will start automatic when OK is pressed and the position of the measurements (from the .kml file) will be shown.

If *Auto start Google Earth* is unchecked you can double click on the .kml file to start GE and showing the measurements.

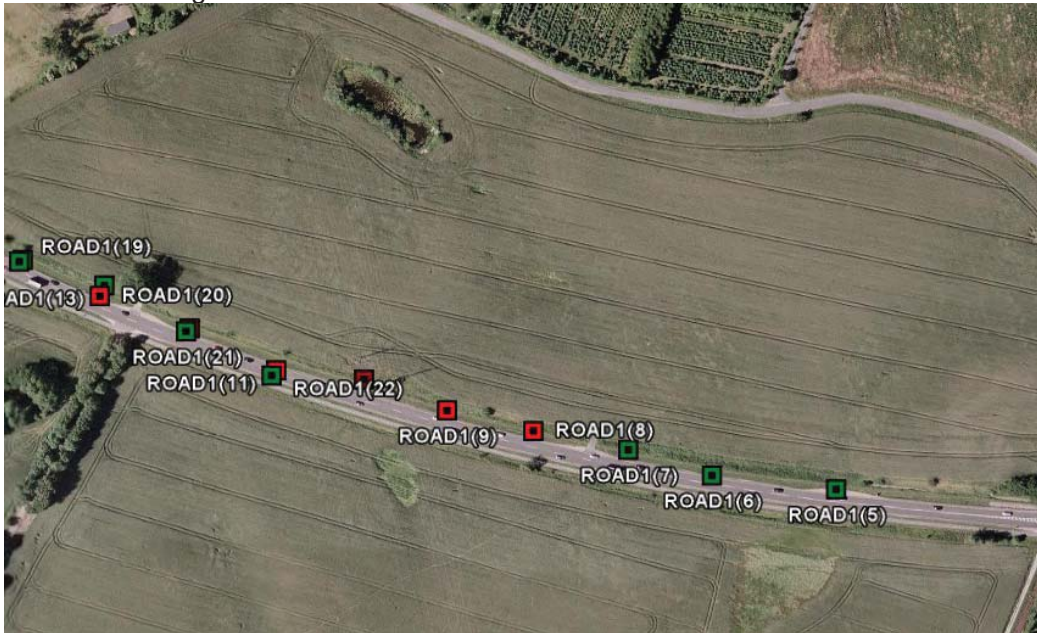

The text shown with the data point in GE is the Series ID and sequence number for the RI measurement.

If you click on a data point in GE a box will pop up showing the further information about the measurement e.g. the RI value.



Note:

Google Earth must be installed on your pc to view the kml data file.

Using "Google Software" you agree to be bound by the following terms of service as well as the terms found on our Legal Notices page at http://www.google.com/intl/en_us/help/legalnotices_maps.html or existing "Gooble Terms of Service".

Understanding Log contents

A line in the Log page represents a single log entry. The selected Road Marking will be displayed as an icon that is identical to the one shown in the LTL-X display. Every measurement has a Status word associated. This status word is presented as a smilie. Three different smilies are possible:



The faces correspond to

- Green: Measurement is good, i.e. no errors or warnings.
- Yellow: A warning occurred, but the measurement is valid.
- Red: An error occurred, i.e. the measurement must be discarded.

A sad smiley may occur if multiple warnings were detected. In this case the result may still be useable (see the LTL-X manual for details).

If you double click on a smiley, a window will be displayed, specifying what particular error or warning occurred.

When you click on a smiley, the status code is copied into Status Code converter in the Options pane.

The following warnings and errors may occur:

Type	Text	Meaning
Error	Measurement error	Some error occurred during measurement.
Error	Xenon timeout error	The Xenon lamp did not flash.
Error	Stray light	Stray light was detected.
Error	More than 40 signal values were saturated	The signal gain is too high i.e. 40 or more samples were out of range.
Error	Calculation error	This might both be an arithmetic, or a instrument fault.
Warn	Low Xenon voltage	The voltage was low during measurement.
	More than 20 signal values were saturated	A high signal was detected, i.e. 20 or more measurements are out of range. This is still acceptable, but the accuracy of the measurement will be decreased.
	Low Signal or Reference offset voltage	The 0-level of the signal or the reference was low. The instrument should be serviced.
	Reference Peak low	The reference signal was low. The instrument should be serviced.
	Reference Peak high	The reference signal is too high, but not saturated. The instrument should be serviced.
	Variance > 3 %	This warning only occurs when doing a calibration. If some of the measurements in a calibration deviate more than 3% this warning will be displayed. Calibrations are not stored in the log.

An icon displaying information about the state of the GPS is displayed too. Three different icons indicate the different states of the GPS data:



FIX: A valid GPS position fix was associated to the measurement.

?: The GPS was turned on, but no fix was associated to the measurement.

X: The GPS was turned off when the measurement was made.

If you double click on the GPS-icon, a message box will display the position or the state of the GPS, i.e. not fixed or no GPS data present.

Options pane

In the Options pane you may setup settings that have influence on your measurements.

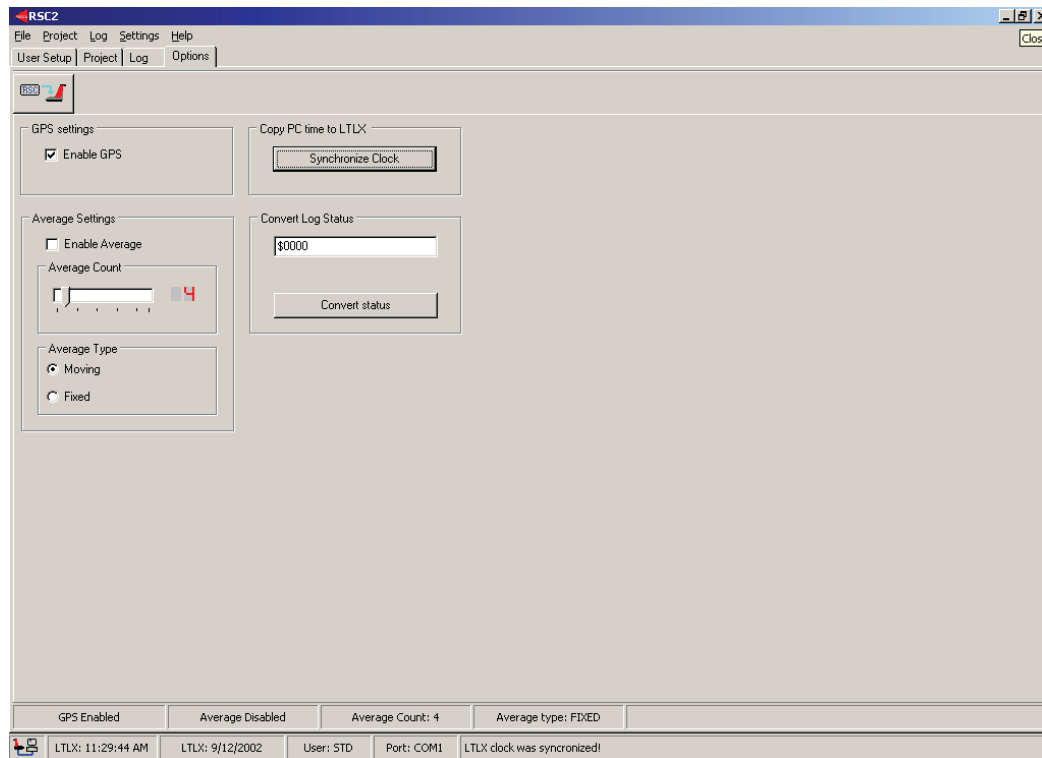

When a LTL-X is connected, the extra status bar at the bottom displays information about the current settings in the LTL-X. If the LTL-X is disconnected, or turned off, the Status bar will be cleared.

Enable GPS:

You may turn GPS on and off.

Copy PC Time to LTL-X:

Pressing the Synchronize Clock button will synchronize the LTL-X date- and time with your computer clock.

Average Settings:

You can setup the LTL-X to manage average measurements.

Selecting the Enable Average checkbox enables the built in average function.

Two kinds of averaging are supported:

Moving average and Fixed average (see LTL-X manual for details).

The number of measurements used for the average calculation is user defined and must be in the range from 2 to 25.

Convert Log Status:

You can convert a numerical instrument status from the log to a more readable form explaining in clear text exactly what conditions led to the status number. Numbers may be entered in both as decimal and hexadecimal.

When you click on a smileie in the log page, the status code is copied into this converter field.

Uploading options

After setting up the preferred settings for averaging and GPS, the user has to press Upload Options.

Settings menu

From the settings menu you can select the COM-port to use with the RSC2 program.

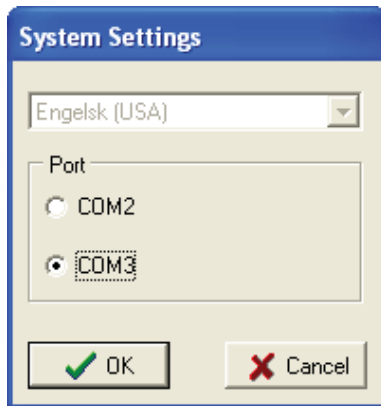

LTL-X

QUICK REFERENCE SHEET

LTL-X Quick Reference Sheet

Start of day / End of day Check Out

- Check the optic window for any dust or dirt, clean with lint free cloth and window cleaner
- Check that the calibration date on the Red field block is not more than 1 week old – if so, do a calibration transfer
- Make sure the battery is charged

Calibration Block Safety

- Always store the calibration blocks in their specific holders when not in use
- Do not touch the white ceramic area of the calibration blocks
- Store the black calibration block in the office, it should never go into the field
- The ceramic face of the black calibration block should never be cleaned

LTL-X Use Overview

- Turn on the LTL-X
- Select User ID
- Select Series ID
- Zero the instrument
- Perform a transfer calibration or a field calibration
- Take Readings

Turn on Instrument

- Press and hold the ON/OFF button, , until the welcome display starts to show (unless the instrument is set to ask for user identification, see User select)

User Select

- Press the Up arrow to access the top line of the display
- Press the Back and Forward arrows to move between icons until the User icon is highlighted (the word User will appear in the second line of the display)
- Press the OK button to enter the user select menu

OR

- Press the Menu button, 
- Select Settings/User/Select
- Select a user and press OK

Series ID Select

- Press the Up arrow to access the top line of the display
- Press the Back and Forward arrows to move between icons until the Series ID icon is highlighted (the word Series-ID will appear in the second line of the display)
- Press the OK button to enter the series id select menu

OR

- Press the Menu button, 
- Select Series ID
- Select Enter ID, Edit or Delete (note: pre-set road markings may be accessed in this screen)

Zeroing Procedure

- Press the Calibration button 
- Mount the unit underneath the front end of the instrument with the ceramic face pointing away from the tower (tilt the instrument slightly backward and then place the pins on the sides of the unit into the holes on the bottom of the LTL-X)
- Press the OK button to start zero calibration (the calibration lamp will flash a number of times)

Transfer Calibration Procedure

- After performing a zero calibration, mount the black calibration unit underneath the front end of the instrument with the ceramic face pointing towards the tower (make sure the pins on the sides of the unit are in the holes on the LTL-X)
- Check the calibration value and correct if necessary (must be the same value as stamped on the calibration unit)
- Press the OK button
- Place the red calibration unit underneath the front end of the instrument with the ceramic face pointing towards the tower and take a reading
- Write the new RI value and date on the label of the red calibration unit

Field Calibration Procedure

- After performing a zero calibration, mount the red calibration unit underneath the front end of the instrument with the ceramic face pointing towards the tower (make sure the pins on the sides of the unit are in the holes on the LTL-X)
- Check the calibration value and correct if necessary (must be the same value as written on the calibration unit)
- Press the OK button

Take Readings

- Place the instrument on the road marking
- Press the OK button

Miscellaneous

Reset Log

- Press the Menu button and select Log/Clear Data/All

Date and Time

- Press the Menu button
- Select Settings/Date & Time
- Use the up and down arrows to set the time and date
- Press OK to accept the settings

Power Save

- Press the Menu button
- Select Settings/Auto Off
- Use the up and down arrows to edit the auto turn off time
- Press OK to accept the settings

Sound

- Press the Menu button
- Select Settings/Sound
- Select Key Click or Sounds to set the individual sound levels for key click and warning/error sounds
- Use the up and down arrows to set the levels
- Press OK to accept the settings

Warnings and Errors

- An error icon (bolt of lightning in a rectangle) or a warning icon (an exclamation mark in a triangle) will be displayed in the top line of the display if a problem is detected
- Press the up arrow to get a description of the most severe error or warning
- Press the OK button to display a list of all errors or warnings related to the measurement